

JOHNSON[®]

For Home Use

Massage Chair MC-J5800

Operation Manual

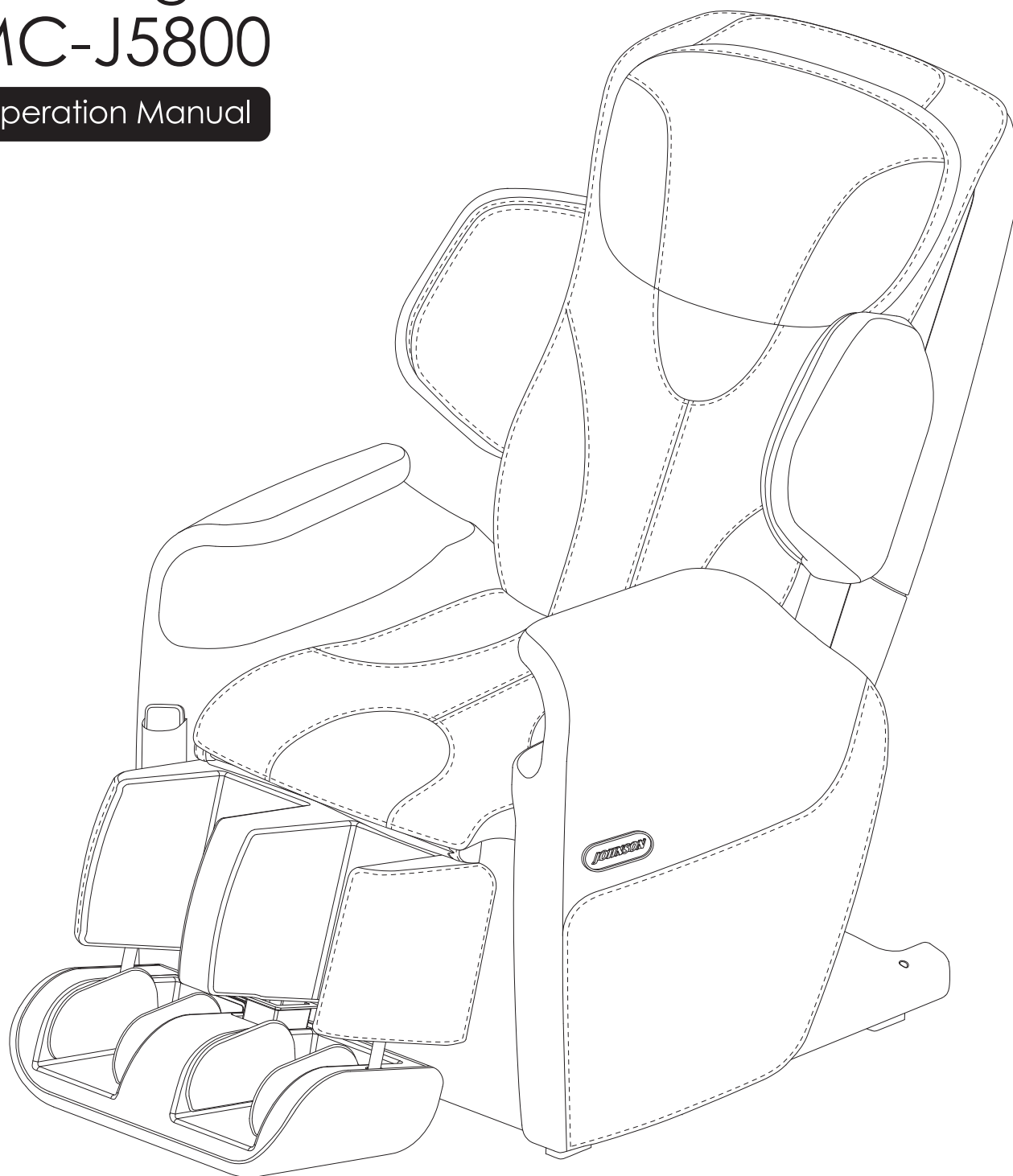

Thank you for purchasing the JOHNSON MC-J5800 massage chair. Please read this manual thoroughly before using the unit. Be certain to read the section on "IMPORTANT SAFETY INSTRUCTIONS" to ensure correct methods of usage. Keep this manual on hand for easy reference.

IMPORTANT SAFETY INSTRUCTIONS

When using the unit, basic precautions should always be followed, including the following:
Read all instructions before using this massage chair.

⚠ DANGER — To reduce the risk of electric shock:

1. Always unplug the unit immediately after use.
2. Always unplug the unit before cleaning.
3. Never use pins or other metallic fasteners with this appliance.
4. Carefully examine the covering of the heating pads before each use.
5. Keep Dry – Do not operate in a wet or moist condition.

⚠ WARNING — To reduce the risk of burns, fire, electric shock, or injury to persons:

1. The unit should never be left unattended when plugged in. Always unplug from outlet when not in use, and before putting on or taking off parts.
2. The unit should not be used on top of heating appliances, such as electric carpets, etc. Do not operate the unit under blanket or pillow. Excessive heating can occur and cause fire, electric shock, or injury to persons.
3. Close and continuous supervision is necessary when this appliance is used by, on or near invalids, or disabled persons.
4. This unit is not intended for use by children. Keep children away from the unit. When the unit is not in use, always turn off the power and unplug the unit.
5. Only use the unit for the purpose described in this manual. Never use any accessories other than those recommended by the manufacturer.
6. Never operate the unit if it has a damaged power cord or plug. Return the unit to the authorized service center if it is not working properly, if it has been dropped or damaged or if it has been immersed in water.
7. Keep the power cord away from heated surfaces. Do not move the unit by the power cord. Keep the plug away from pins, dirt or moisture (use a dry cloth to remove dust).
8. Never operate the unit with the air openings blocked. Keep the air openings free of any lint, hair, and the like. Do not drop or insert any objects into any opening of the unit.
9. Do not use this unit in bathrooms or any other damp or humid locations as this may cause electric shock or lead the unit to malfunction. Do not spill water, etc, on the controller or the unit.
10. Do not use the unit outdoors.
11. Do not use the unit where aerosol spray products are being used or oxygen is being administered.
12. Always lift the back pad to check that the fabric of the unit itself has not been ripped. No matter how small the rip is, if you find one, immediately stop using the unit, unplug the power cord, and have the unit repaired at an authorized service center. Use of the unit with ripped fabric may cause electric shock or injury.
13. Turn off all control switches before unplugging the unit from the power outlet. A transformer should not be used as this may cause electric shock or lead the unit to malfunction.
14. Do not stand on or in appliance. Use only while seated.
15. Connect the unit to a properly grounded outlet only. Please see Grounding Instructions.
16. Do not attempt to open or disassemble any parts of the unit to avoid electric shock or injury to persons.
17. Temperatures sufficiently high to cause burns may occur regardless of the control setting. Do not use on an infant or invalid or on a sleeping or unconscious person. Do not use on insensitive skin or on a person with poor blood circulation. Check the skin in contact with the heated area of the appliance frequently to reduce the risk of blistering.
18. Do Not Crush – Avoid sharp folds.
19. Burns will result from improper use. Read the instruction before using. Do not wet. Do not use pins. Never remove cover.
20. The appliance has heated surfaces. Persons insensitive to heat must be careful when using the appliance.
21. Keep children away from extended foot support (or other similar parts).
22. Risk of electrical shock and moving parts. Disconnect from power supply before removing enclosures, cleaning or servicing.
23. The appliance has not user serviceable parts inside.
24. The appliance is not to be used by children or persons with reduced physical, sensory or mental capabilities, or lack of experience and knowledge, unless they have been given supervision or instruction.
25. Children shall be supervised to ensure that they do not play with the appliance.
26. Press the red marked emergency stop button on the remote controller if you experience any problems or discomfort during use. All operation will be immediately stopped.
27. The assembly/installation must be done by the dealer or its service agent or a similarly qualified person, in order to avoid a hazard.

SAVE THESE INSTRUCTIONS

WARNING

1. Persons with any of the conditions listed below or who are undergoing medical treatment should consult with their physicians before using this unit:
 - 1) People who have a pacemaker or other medical devices that are prone to electromagnetic interference.
 - 2) People suffering from heart diseases.
 - 3) Pregnant women, people who are ill, or in poor physical shape.
 - 4) People who are prohibited from receiving massage by a physician due to thrombosis or aneurism, acute varicosity, dermatitis or skin infections (including inflammations of subcutaneous tissue).
 - 5) People suffering from osteoporosis, spinal fracture, acute (irritation) diseases.
 - 6) People with irregular curvatures of the spine.
 - 7) People suffering from perceptual disturbance caused by severe peripheral blood circulatory disturbance such as Diabetes.
2. Never put your hands or feet between the knead balls as this may cause discomfort or injury. Never put your fingers, feet or head in the gap between the backrest and the seat, the backrest and the armrest, the seat and the cover under the armrest, the footrest and the seat base, the back cover and the base cover, and the back side of the footrest to avoid injury.
3. Do not use the unit against bare skin, as exposing the skin directly to the unit may cause irritation. Do not use the unit wearing hair accessories or anything hard on your head. While massaging the back of the neck, attention should be paid to the knead balls movements. Excessively strong massage should be avoided on the back of the neck.
4. Be sure to start on the gentle massage program if using the unit for the first time. The unit should not be used for more than a total of 15 minutes each session. Avoid massaging the same spot of your body for more than 5 minutes at a time. Excessive massage can over-stimulate the muscles and nerves and result in an adverse effect or injury. The recommended duration of use is under 30 minutes a day.
5. Stop using the unit immediately should you experience any discomfort, and consult the physician.
6. Do not fall asleep while using the unit, or use the unit after drinking alcohol.
7. Do not sit on the backrest, footrest, shoulder, armrest, or stand on the seat to avoid accident or injury caused by falling over.
8. If the unit can't be operated or functions abnormally, please immediately turn off the power, unplug the unit and contact an authorized service center for inspection and repair.
9. Never attempt to repair or disassemble the unit by yourself.
10. Make sure there are no obstacles behind the unit before reclining it. If the back hits a wall or pillar, the unit may malfunction. Be sure to have sufficient space behind the unit.
11. When the unit is not in use, turn off the power and unplug the unit. Or, it may result in accident or injury due to child's mischief.
12. When body sensing is performed, always make sure that the shoulder position is in the correct position. If it is not properly aligned, use UP / DOWN button to adjust the shoulder position, or stop the massage and perform the body sensing again.
13. Sit on the unit after confirming there is no foreign object between the parts of the unit. Check the knead balls position for the sake of safety before lean on the unit slowly. Do not attempt to sit down or stand up with the footrest raised to avoid accident or injury.
14. Remove hard objects, such as fake fingernails, wristwatches, rings or bracelets before massaging the hands or arms. Remove any hard object in your trousers pockets before massaging the thighs and hips. Remove any earrings, necklace or scarf before massage to avoid injury.
15. In case that the backrest cover cloth is slightly broken, with holes because of wear, stop using the unit immediately. Do not attempt to take down, tear and cut the cloth. Never use the unit with damaged backrest cover cloth, as clothing or hair may be caught inside and cause injury.
16. Do not pull on the footrest rotation lock release lever while sitting in the chair with the legs on the footrest. Accident or injury may occur.
17. The unit should not be carried or moved during installation. Do not move the unit using the wheels over wooden floors, carpets or any other surface prone to scratches to avoid damage to the surfaces.
18. Do not hold on the footrest / sole massage section when moving the unit as the section may slide as you move the unit and accident or injury may occur.
19. Do not damage the power cord. Do not attempt to damage, bend, pull, twist or tightly bundle the power cord. No heavy object should be placed on the power cord; in particular, ensure that the cord is free of obstacles when moving the unit as damaged power cord may result in fire or electric shock.
20. Do not unplug the unit or turn off the power supply when the unit is in use.
21. Do not use the unit if the plug or the outlet becomes loose to avoid the risk of electric shock or short circuit.
22. Do not use the unit on other than the designated voltage to avoid the risk of fire, electric shock or malfunction.

OPERATING PRECAUTIONS — To avoid damaging the unit:

1. Use the unit only when it is placed on an even, flat surface. Failure to observe this may result in upset.
2. Make sure that the control switches and timer function are working properly prior to operating the unit.
3. Prior to operating the unit when it has not been used for a long period of time, read this manual carefully and make sure that the unit is still in good condition to avoid accident or injury.
4. Handle or move the unit with care to prevent from scratching the floor.
5. Only connect the power cord to a properly grounded outlet. The grounding plug should not be bent or disconnected; or, electric shock may occur during electricity leakage or malfunction.
6. Do not stand, sit or place any objects on the backrest, armrest or footrest.
7. Never use the unit against wet skin to avoid electricity leakage or electric shock.
8. At the time of power outage, immediately turn off the power switch and unplug the power cord from the outlet to avoid accident in case the power is restored.
9. During maintenance, the power cord should be disconnected from the outlet. Do not plug / unplug the power cord with wet hands to avoid electric shock or injury.
10. Unplug the power cord by holding the plug but not pulling the cord to avoid electric shock or short circuit causing sparks.
11. When the unit is not in use, always unplug the unit from the outlet to avoid the risk of electricity leakage or fire caused by insulation aging due to dust or humidity.
12. Do not use the unit in a swimming pool area, in the bathroom or places where humidity is high.
13. Do not place the unit in areas exposed to direct sunlight, or near heaters, hot air blowers or any other heating devices to avoid discoloration or deterioration on the surface of the holster.
14. Do not use the unit near heaters or other places with a high temperature. Do not use the unit while smoking, or on electric blanket or other heating devices, to avoid causing a fire.
15. Do not move the unit with any person or object on it to avoid malfunction or injury.
16. Only one person should be seated in the unit at one time to avoid malfunction or injury.
17. When the unit is inoperative, repairs should only be carried out by qualified technicians. Never attempt to disassemble or repair the unit by yourself.
18. Any repair or service should only be performed by an authorized service center.

GROUNDING INSTRUCTIONS

The unit must be properly grounded. If it should malfunction or break down, grounding will provide a path of least resistance for the electric current to reduce the risk of electric shock. The unit is equipped with an insulated cord and a grounding plug. The grounding plug must be plugged into an appropriate outlet which has been properly installed in accordance with local regulations and standards.

DANGER

Improper grounding may lead to electric shock. Check with an authorized service center if you are in doubt as to whether the unit is properly grounded. In case the supplied plug does not match the outlet, do not attempt to modify the plug. Please contact a qualified electrician to have a proper outlet installed.

This unit has a grounding plug. Make sure that the unit is connected to a power outlet with the same configuration as the plug. Do not use an adaptor with this unit.

Before Use

— Setting up the massage chair

- Ensure adequate space around the unit and place it on a flat surface. Avoid placing the unit exposed to direct sunlight or near any heating device or in other locations with a high temperature to avoid discoloration or deterioration on the surface of the holster or back pad.
- It is recommended to place a carpet or soft mat underneath the unit to avoid damaging the floor. The size of such carpet or mat should be large enough to cover the surface where the unit and the footrest may come in contact with the floor (minimum 120 cm X 70 cm).
- With the backrest reclined backward, the footrest goes up. To avoid collision with any surrounding objects, a clearance of at least 45 cm at the front and at least 50 cm at the back should be reserved around the unit.

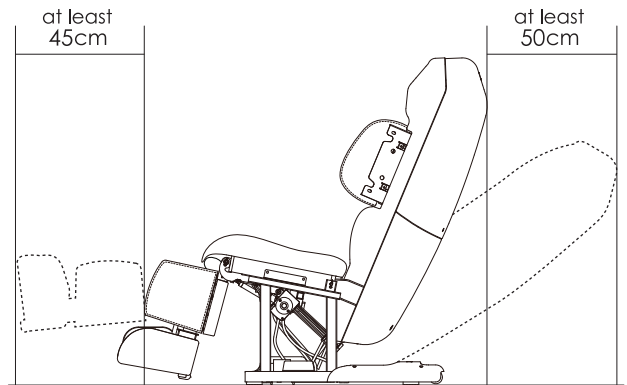





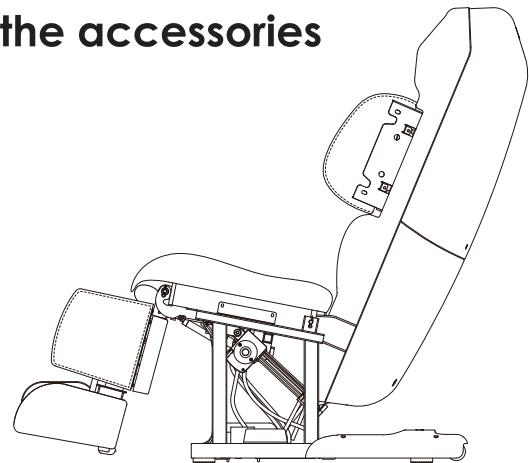

— Take out the main unit and all of the accessories from the box for installation

• Main unit

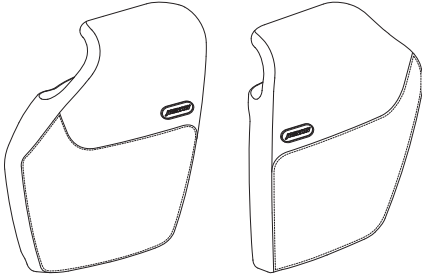
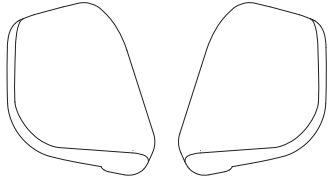
As the unit is very heavy (approximately 90 kg), please handle with care to avoid injury. (This unit must be carried by two or more persons.)

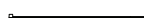

• Accessories

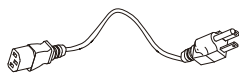
<p>Armrest</p> 	<p>shoulder parts</p> 
<p>Screw Kit</p>  <p>M8 x 1.25P x 16L Cross-head screws x 4 pcs.</p>  <p>Cable Ties x 2 pcs.</p>  <p>M4 x 0.7P x 10L Cross-head screws x 4 pcs.</p>  <p>M5 x 0.8P x 20L Cross-head screws x 4 pcs.</p>	<p>Tool Kit</p>  <p>Screwdriver</p> <p>Power Cord</p> 

— Assembly

1. Installation of the left armrest

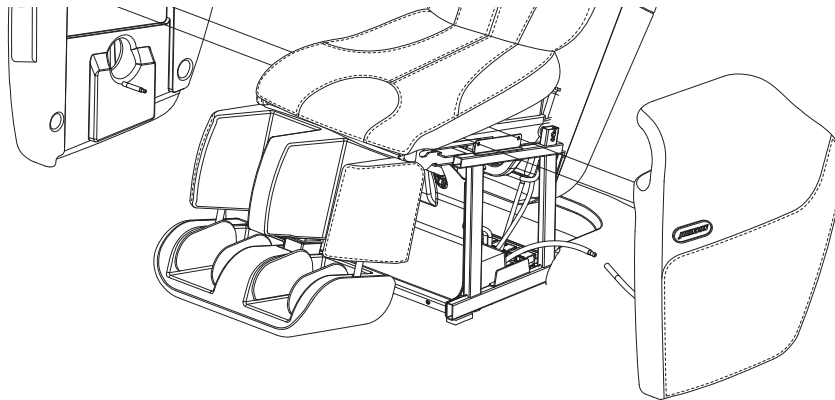

① Connect the air plug for the armrest. Firmly insert the air plug into the air pipe of the armrest and use cable tie to bind the connecting point of the air plug and air pipe. Lean the left armrest against the left side of the base frame. Align the convex of the base frame with the mounting holes inside of the armrest. Press firmly.

② Fasten the left armrest with M5 x 0.8P x 20L cross-head screws firmly on the left side of the base frame.

2. Repeat the steps to install the right armrest on the right side of the base frame. Then, place the remote controller in the pocket on the right armrest.

3. Installation of the shoulder parts

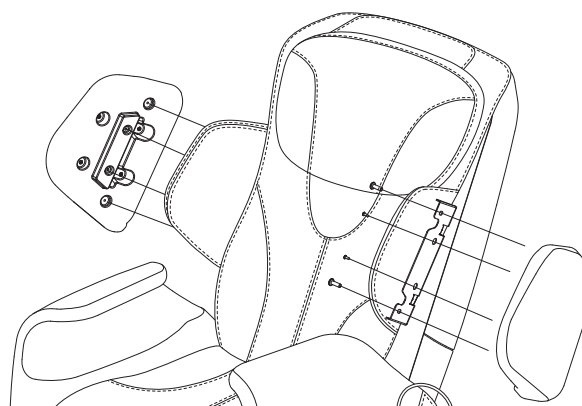

Put the shoulder part onto the iron plate first, then let the iron plate be inserted into the shoulder part. Fasten the shoulder parts by M8x1.25Px16L and M4x0.7Px10L cross-head screw firmly on the iron plate.

Your attention: The zipper cannot be shut if the shoulder parts are put on the wrong side.

4. Installation completed.

- 1 When massaging, lift the big pillow and adjust the small pillow to the appropriate position.

- 2 If you feel the massaging strength is less strong, remove the back pad (leave the small pillow in place) to enhance contact of the knead balls with your back.

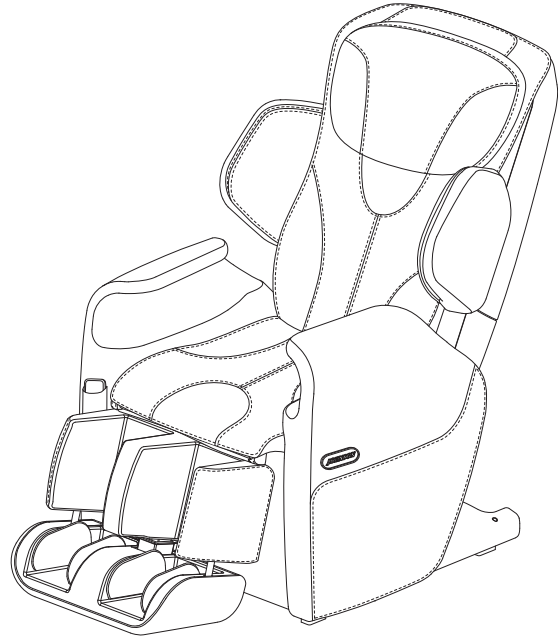

⚠ WARNING — Before use, lift up the back pad to make sure that there is no tear on the backrest cover cloth as well as on the other parts.

(Should there be any tear, no matter how small it is, immediately unplug the power cord and contact the service center.)

5. Connect the power cord to the unit.

Make sure to completely insert the connector into the appliance inlet.

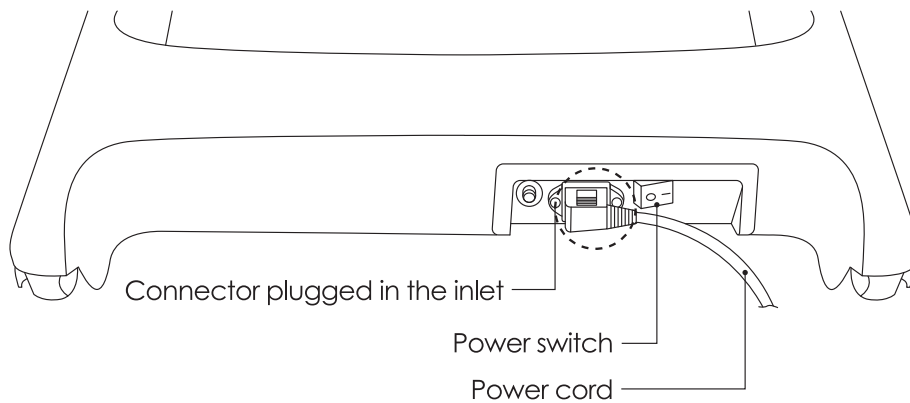

6. After installation is completed, insert the power plug into the power outlet. Turn on the power switch and press ON/OFF button on the remote controller to start select the massage functions.

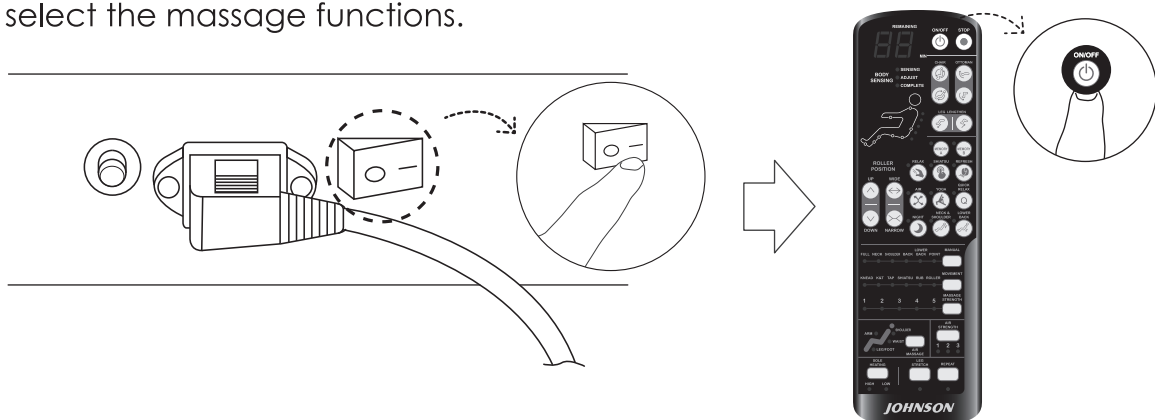

— Moving the massage chair

1. Move the chair with the casters

Push down the upper part of the backrest, tilt up the front side of the chair and put it forward.

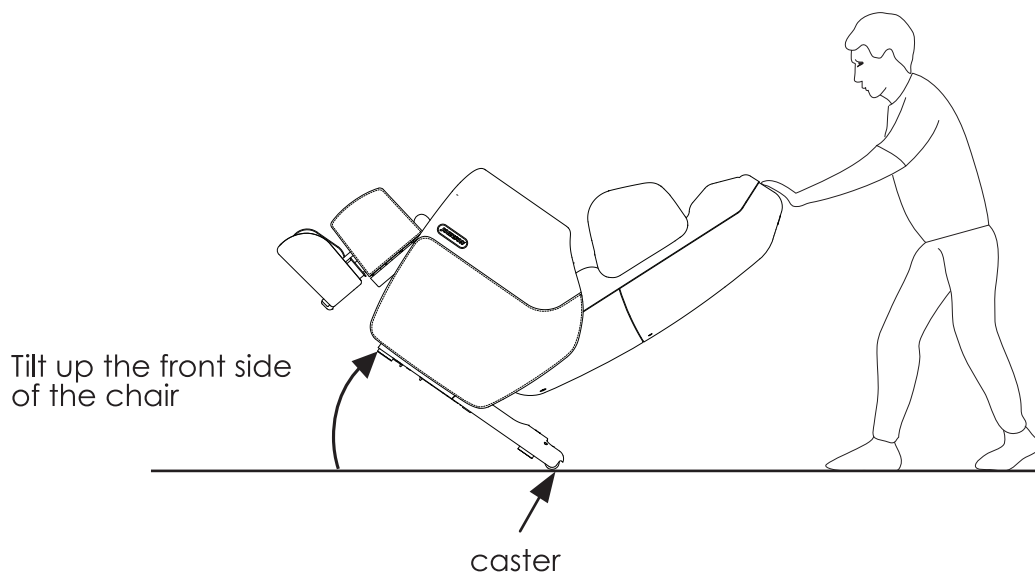

Tilt up the front side of the chair and use the caster to move the chair forward.

⚠ CAUTION

- Do not move the chair with a person or any object seated on it to avoid upset.
- Do not move the chair with its casters or drag the chair on floor surfaces prone to scratching.
- Do not hold the seat, the footrest and the shoulder unit to move the chair.
- Balance the weight with care while lifting up the front side of the chair.

2. Handling by 2 persons

When the unit is being handled by 2 persons, recline the backrest and move the chair by one person holding the back and the other person holding onto the side of the footrest.

⚠ CAUTION

- The power cord should be properly arranged and placed on the seat to avoid any damage during moving.
- Move and place the chair down slowly with care to avoid damage to the internal parts.
- Do not move the chair with its casters on the uneven surface.
- Do not move the chair with its casters on the wooden floor or other slippery surface to prevent scratches. If necessary, the chair should be carried by two or more persons.

Part Names and Functions

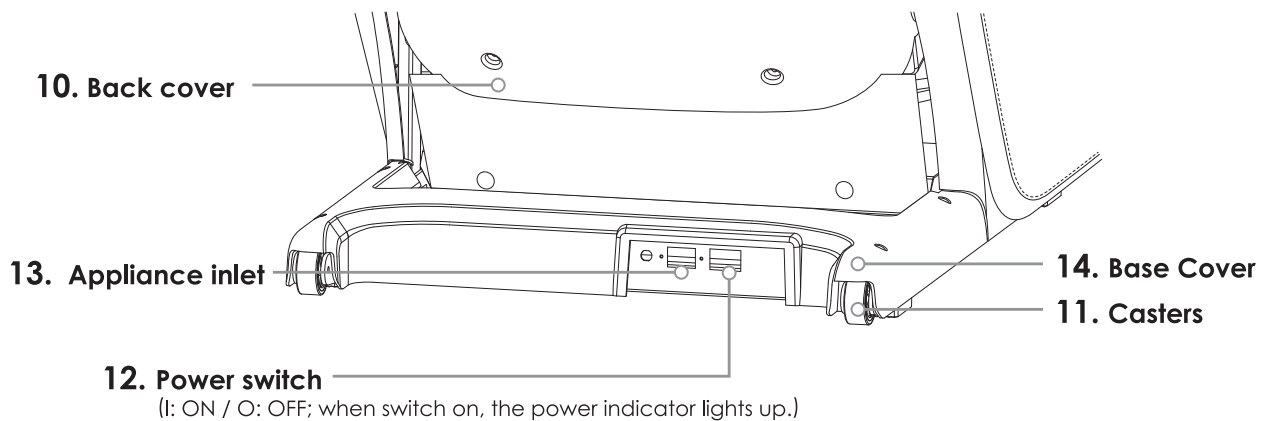
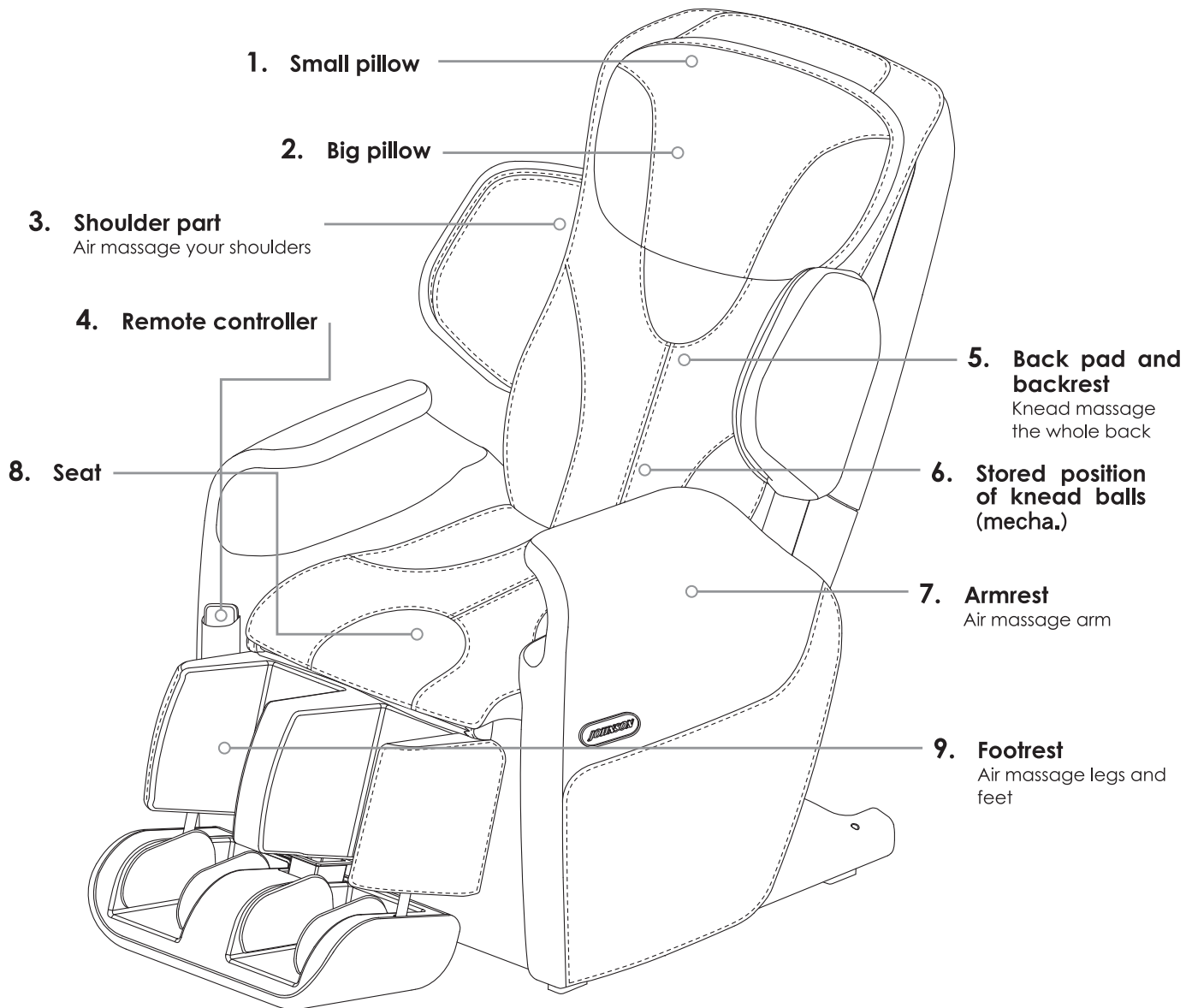

Massaging positions

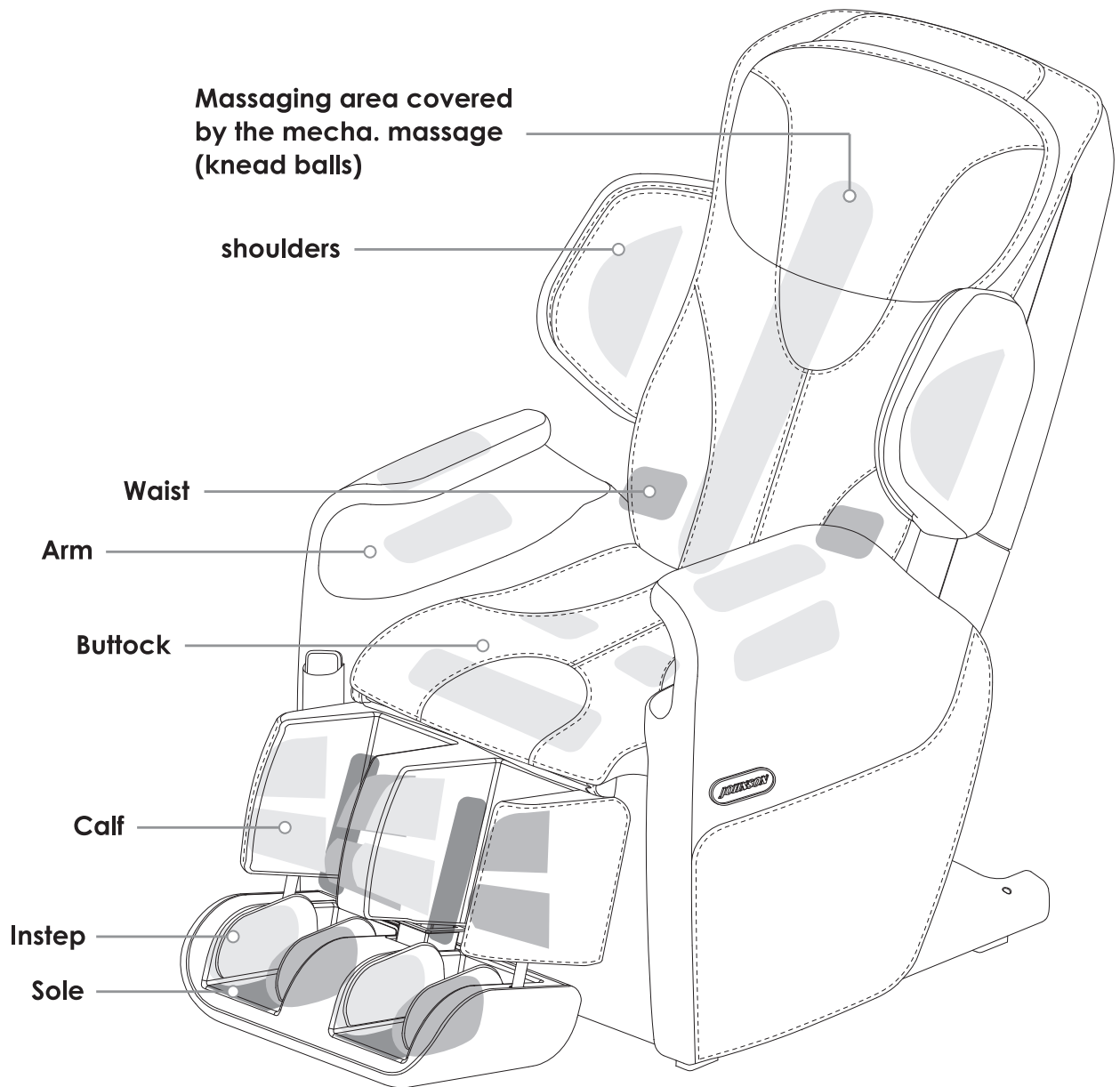

Remote Controller

Key functions

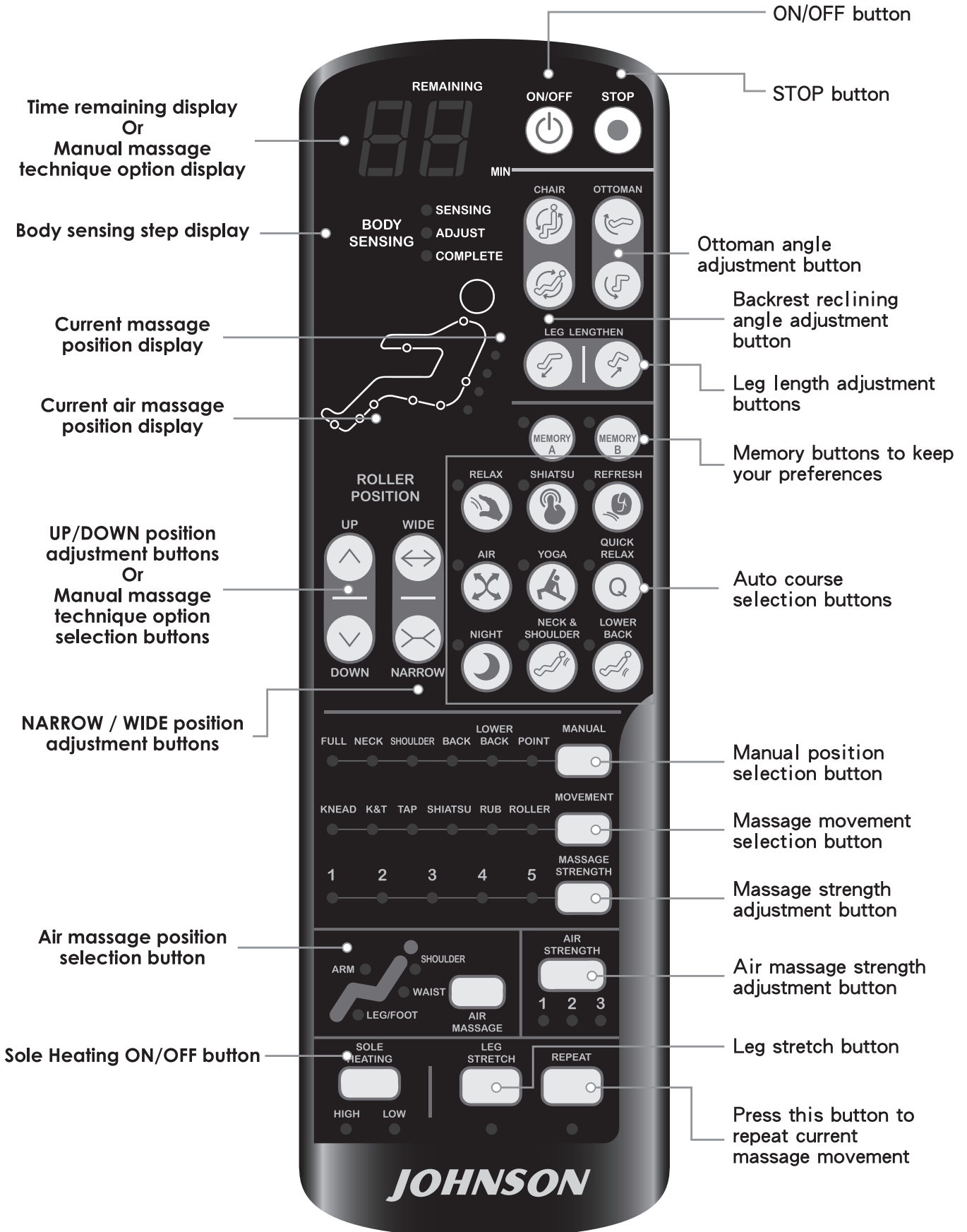

Before Starting Massage

Power On

1. Connect the power cord plug with the receptacle.

- Check if the power cord, remote controller cord or power plug is damaged and check whether there is any hair or dust on the plug.

2. Turn on the power switch.

- The power switch is located at the lower right side of the base.
- Confirm that the switch is in the I (ON) position (When the power is on, the power indicator lights up).

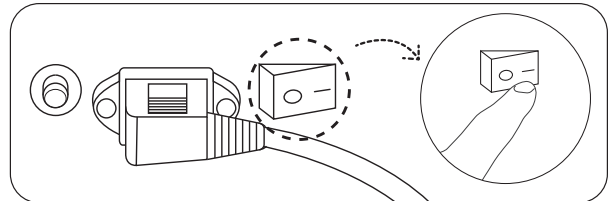

3. Make sure to check the surrounding conditions.

Make sure that there is no person, pet or object behind the chair, in front of and below the footrest.

4. Check the condition of the massage chair.

- ① Hold up the back pad and check for any tear in the backrest cover cloth as well as in any other parts.
 - ※ Should there be any tear, no matter how small it is, stop using the unit immediately, unplug the power cord and have the unit repaired.
- ② Check whether the power cord, remote controller cord or any other object is pinched in the main body.
- ③ Before seated on the chair, make sure where the knead balls are stored.
 - The knead balls are usually located at the stored position (in the innermost at the lower part of the backrest).
 - When the knead balls are not located at the stored position, press the ON/OFF button, they go back to the stored position.
- ④ Before seated on the chair, make sure that the footrest is at the stored position.
 - It may cause injury if being seated forcibly with the footrest at the upright position. Press Ottoman angle adjustment button to lower the footrest.
 - ※ When pressing the ON/OFF button, the backrest will also be returned to the stored position.

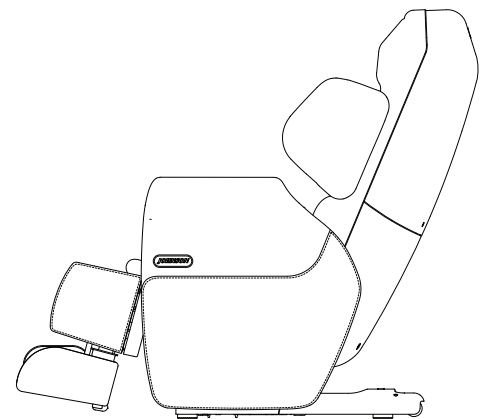

5. Adjust the position of the small pillow.

Adjust height of the small pillow so that the lower edge of the pillow is at the upper edge of your ears.

- If the position of the pillow is too low, the pillow may get in the way while performing neck massage.
- When the reclining angle is adjusted, the pillow position may change. In such case, please re-adjust its position.

How to Adjust the Chair

— When you want to adjust the reclining angle and / or footrest

1. Press  to turn on the power.

- When the unit has been idling for over 3 minutes without operation, the remote controller display will automatically shut down.

2. Press  or  to adjust the angle.

- Hold on the button to keep the backrest or footrest move until a beep-beep-beep" sound is heard.

3. Press  button to adjust the length of the footrest.

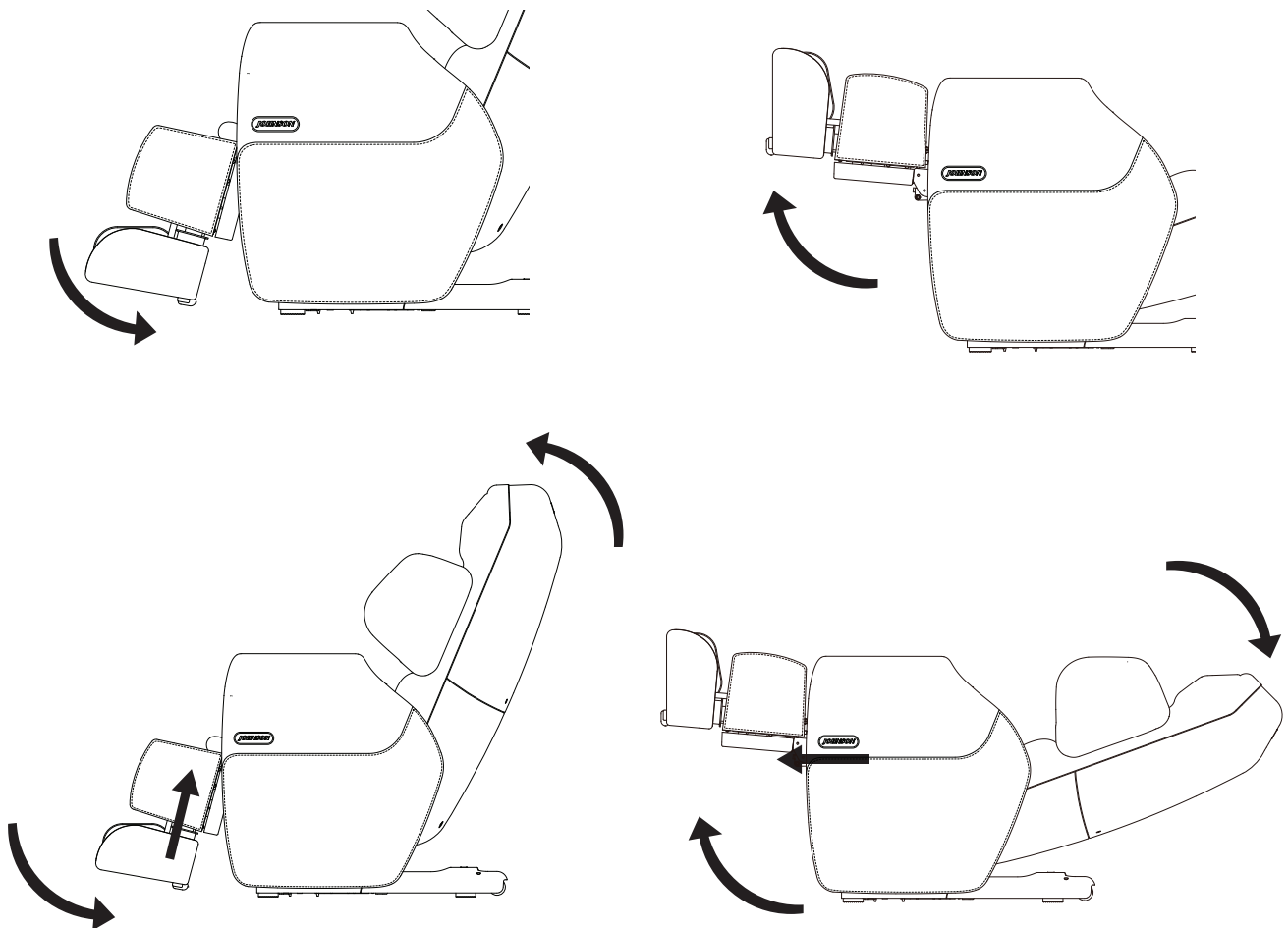

How to Use the Auto Mode Course



1. Press to turn on the power.

- When the unit has been idling for over 3 minutes without operation, the remote controller display will automatically shut down.
- ※ Press "ON/OFF" and select a desired course, the backrest and the footrest will be automatically set to the standby position.
- ※ The knead balls and the chair will first return to the stored position if they are not in the stored position when "ON/OFF" is pressed. Then the backrest and the footrest will be automatically set to the standby position.

2. Press one of the buttons to select the desired course.



Characteristics of auto mode courses (Upper Body)

- **RELAX**
To relax the muscles, from neck and shoulder to lower back, mainly by kneading techniques and with specific and slow shiatsu movement.
- **SHIATSU**
This is a course to ease points of muscle stiffness, from neck to lower back, mainly by shiatsu movement.
- **REFRESH**
From neck and shoulder to low back, stimulate the sore spots to relieve the body tension by diverse tapping techniques and slow & intense kneading movement.
- **AIR**
Inflate/leak the air to the air-bag to massage your leg/foot, buttocks, waist, arm and shoulder to make your whole body feel fully relaxing.
- **YOGA**
This course helps to stretch and twist the body through the movements of the air bags.
※ In some stretching movements, the knead balls will move to a position above the head for standby and provide a more comfortable posture.
※ During the course, "LEG STRETCH" cannot be disabled and the angles of the backrest and the footrest cannot be adjusted.
- **QUICK RELAX**
This 7-minute course gives quick relaxation, from neck and shoulder to lower back, relieve fatigue through comprehensive massage techniques.
- **NIGHT**
This course helps to relax the body and mind for a good night's sleep.
- **NECK & SHOULDER**
To loosen the muscles of neck & shoulder and upper back mainly by neck relax technique and with specific, slow, intense 3D kneading and tapping movements as well as up-down kneading techniques and help de-stress the body.
- **LOWER BACK**
Through deep kneading and tapping techniques to relieve the tension and aches on the waist, buttocks and the middle back.

3. Users whose height is less than 140 cm or more than 185 cm are recommended to use the unit in the manner described below when the shoulder position can not be properly adjusted.

① Height is around 140 cm or less

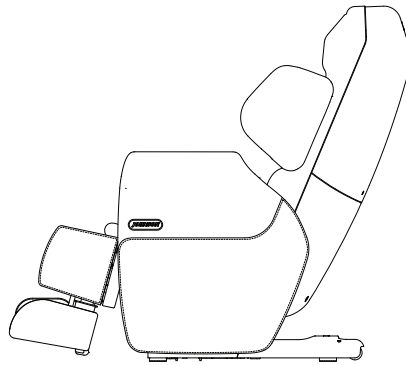

Place a cushion on the seat and sit as far back as possible.

② Height is around 185 cm or more

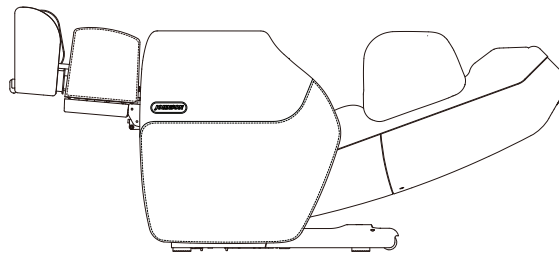

Recline the backrest and slide the body downward.

4. Body sensing will start ("sensing" indicator blinks) after a desired course is selected.

5. After the body sensing, the knead balls will slowly move down to the shoulder position, and a light tapping ("adjust" indicator blinks) action begins to determine your shoulder position. If the user does not make any adjustment within 5 seconds, the shoulder position will be automatically determined and the course starts, and "complete" indicator will be displayed.

6. To adjust the shoulder position during the tapping action.

- If the shoulder position is incorrect, press the UP/DOWN position adjustment buttons while the light tapping is in progress (approx. 5 sec) to move the knead balls up or down. After adjusting the shoulder position, confirmation will automatically be made if no further adjustment is made within 5 seconds.

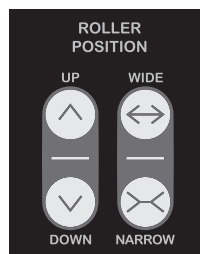

Each time the button is pressed, the knead balls will be moved approx. 1 cm up or down.

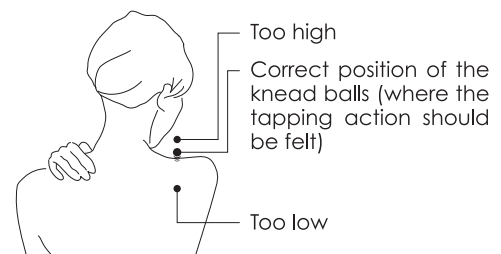

Adjust the knead balls until the upper part of the shoulders receives light tapping.

7. Body sensing is completed when the tapping finishes.

- If the shoulder position is off drastically, turn off the power. Adjust the shoulders position firmly pressed against the backrest and repeat from Step 1 in this section.

Customized Massage

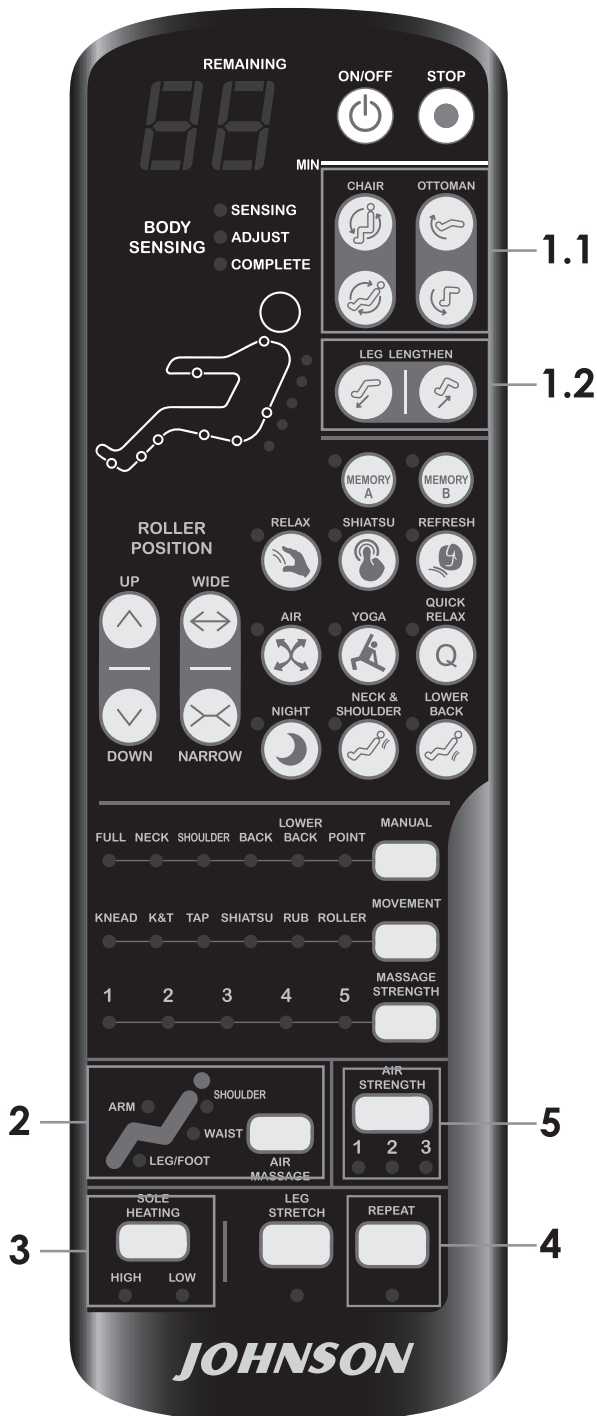

1. Adjusting the reclining angle and the footrest angle for a comfortable massage.

- 1 Press  to adjust the reclining angle and the footrest angle.
- 2 Adjust the extension of the footrest: Straighten your legs can extend the footrest, if you still need longer length, press the  to adjust till you feel comfortable.

2. Disable / enable the air massage position.

Press AIR MASSAGE position selection button on the bottom of the remote controller to disable / enable air massage positions. Disable / enable of the air massage position can be confirmed by the indicators. (Lit: Enable; Off: Disable)

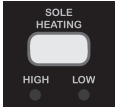

3. Adjust the temperature of the sole heater or turn it on/off.

Just press the  button to change the temperature you like or turn on/off of the heater.

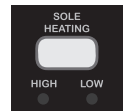

- Your attention: The sensed temperature varies depending on the body shape, massaged area, massage movement, clothing and ambient temperature.

4. Repeat current massage movement.

Press  to repeat current massage movement.

- "REPEAT" command may not be accepted when the massage movement is switching.
- When "REPEAT" function is enabled, the indicator will lighten.

5. Changing the air massage strength.

While performing the air massage on hand/arm, or leg/foot, the massage strength can be adjusted by

pressing .

- See page 15 for description on the use and operation of the air massage.

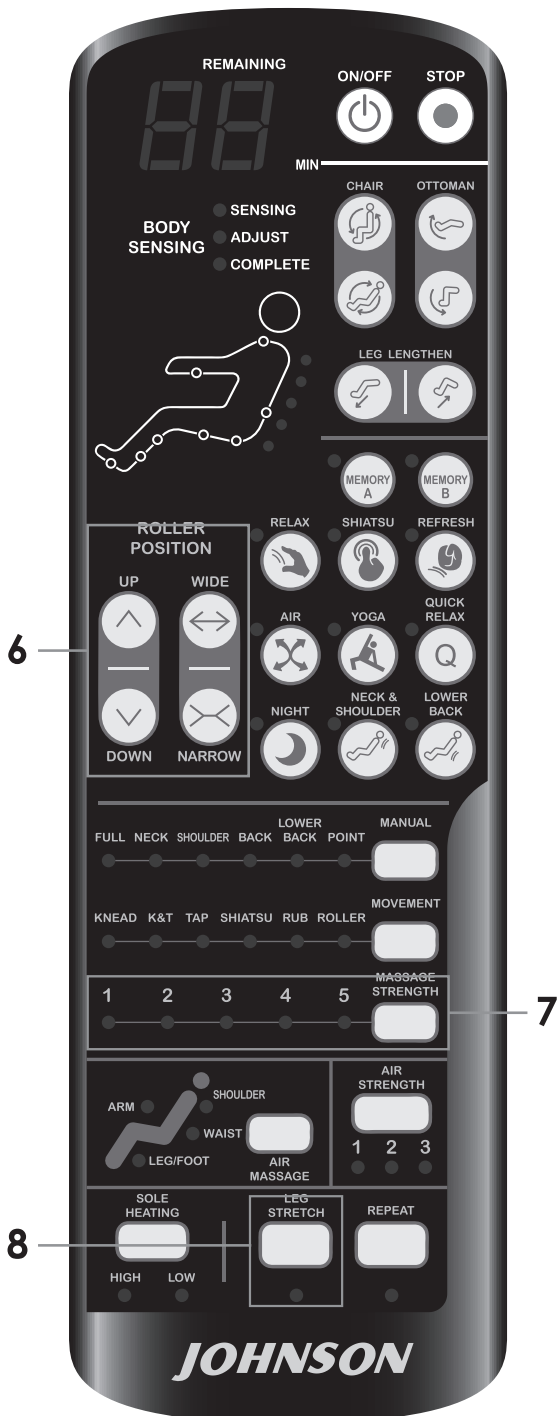

6. Fine-adjustment of the position

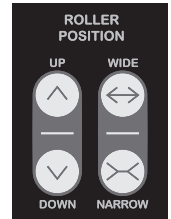

7. To adjust the massage strength.

Massage strength can be adjusted

by pressing .

- Current position currently being massaged can be checked on the indicator.
- There are 5 levels of the massage strength in the auto mode course.
- When the strength reaches the maximum, the strength will start from the minimum if you keep pressing the button.

※Caution

Strength might increase drastically when the strength is increased in multiple steps. The strength should be adjusted one step at a time based on the user's comfort.

- If the massage strength is still unsatisfactory even when the maximum or the minimum has reached: (When it is not strong enough even the massage strength in the auto mode course has been set to the maximum)

You can increase the strength by reclining the backrest and making use of your body weight.

(When it is still too strong even the massage strength in the auto mode course has been set to the minimum)

You can place a cloth or a blanket between the backrest and your body to reduce the pressure of the knead balls.

※Note

You may not feel the difference in intensity for massage even if the massage strength or air strength button is pressed:

- When the intensity was increased right when the operation has changed.
- The feeling is different depending on the individual or the position.

8. To disable/enable LEG STRETCH during the course

Press .

- To disable/enable LEG STRETCH by pressing this button. The indicator will not lighten when there is no leg stretch movement during the auto course.

Registration in the Memory

Auto mode courses

You can register your preferred settings set during the course, and have it reproduced next time you are massaging.

1. After the auto course has finished, or when the massage is completed by pressing ON/OFF during the course.

Your preferred settings are displayed and the MEMORY buttons will flash. 

2. Select and press one button from that you would like to register while the buttons are flashing (approx. 10 sec).

- Selected button will light. (e.g. )

Example: When using REFRESH course

- 1 You have set AIR MASSAGE "SHOULDER" and "LEG/FOOT" to "On". (The air strength was set to "Level 1" at this time.)
- 2 HEAT function was set to "Off" and massage strength was set to level 3.
- 3 "TAP" was set to "On".
- 4 These settings were registered to MEMORY A after the massage completed.

The registered settings (as described in , and) are restored if MEMORY A is pressed when "REFRESH" course is used.

The registered settings (as described in 1 2 and 3) are restored if MEMORY A is pressed when "REFRESH" course is used.

3. When the registration is completed.

- Pressed button will turn off, and the power will be turned off automatically within 2 seconds.

※Please note that settings will not be saved when the power switch is turned off or the power cord is disconnected during the massage.

Contents that can be registered

- Settings for air strength and massage strength
- On/Off setting for HEAT function
- On/Off setting for AIR MASSAGE
- On/Off setting for TAP enable/disable function
- On/Off setting for LEG STRETCH
- Settings set at the time the auto course is completed will be registered.

If there is another setting already registered, the memory button will flash quickly.

- To update to the new settings, press the same button again. If no action taken within 5 seconds of the quick flashing, no new setting will be updated.
- If you do not want to delete the setting already registered, press the other MEMORY button.



To start the registered course

- Press  to turn on the power.
- When the unit has been idling for over 3 minutes without operation, the remote controller display will automatically shut down.
- Select the MEMORY button that is registered. Button A will light if A were registered. If a button with no saved data is pressed, such as button B or C, it will beep to indicate that button B or C has not been registered.
- Select and press one of the auto courses that is registered. (Example: REFRESH). Massage with registered setting will start after the body sensing.



4. To delete the registered settings.

- ① Press  to turn on the power. Press the button for the setting you wish to delete.
- ② Press again and hold for 3 seconds until the button changes to flashing.
- ③ Press again during the button flashes. Delete is completed once the flashing stops.
 - ※ If no action taken within 5 seconds after the button starts to flash, no setting will be deleted.

How to Select a Preferred Massage Position and Massage Movement

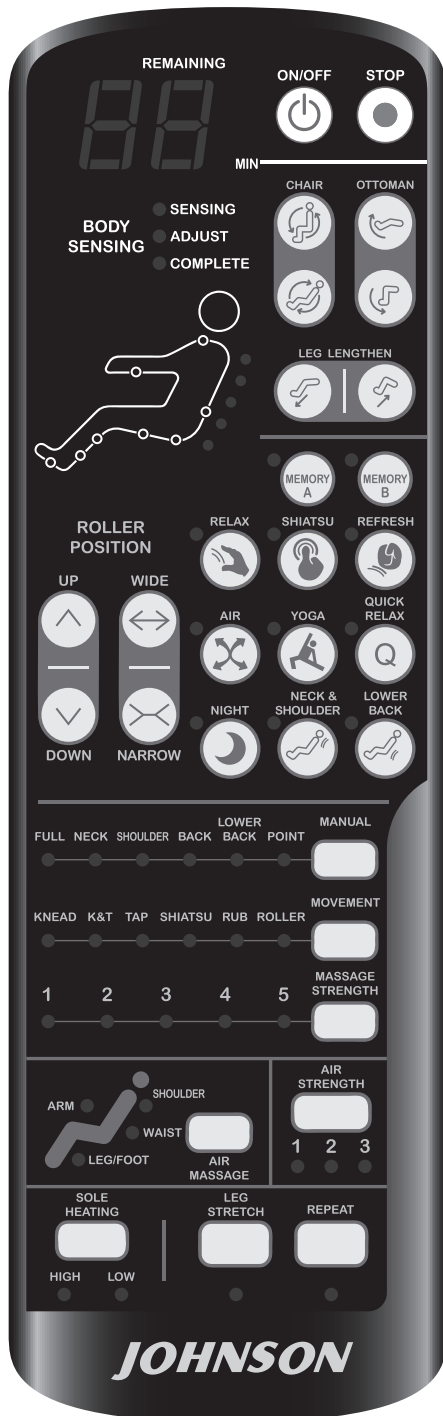

Manual operation

1. Press  to turn on the power.

- When the unit has been idling for over 3 minutes without operation, the remote controller display will automatically shut down.

2. Select the preferred position to be massaged.

Choose from: FULL BACK, NECK, SHOULDER, BACK, LOWER BACK or POINT.



3. Select the preferred movement.

- The massage movement can be selected by repeatedly pressing the button. Each position has been preset with the optimal massage technique.

- To use , you can select other available massage

techniques under the pre-selected movement, confirmation will automatically be made if no further adjustment is made within 5 seconds.

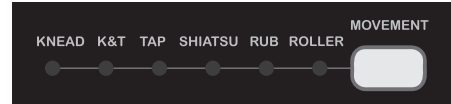

Body sensing for Manual Operation

- FULL BACK / NECK / SHOULDER: normal body sensing
- BACK / LOWER BACK: simple body sensing (the knead balls will not move up to the shoulder position.)
- POINT: no need for body sensing

To change the position or the movement in the middle of a massage

- Select your preferred massage position or movement again in steps 2~3, confirmation will automatically be made if no further adjustment is made within 3 seconds.
- Without changing the massage position, you can press

 to select other massage techniques under the pre-selected movement. Within 5 seconds while the

indicator is blinking, use  to select the massage

technique or you can repeatedly press  to select the massage movement.

To customize

1. Adjusting the reclining angle and the footrest angle for a comfortable massage.

To adjust the reclining angle and the footrest angle

by pressing  buttons.

4. Changing the air massage strength

When performing the air massage, adjust by pressing

 button.

- Strength is displayed in 3 levels.

2. Using air massage together

Disable / enable of the air massage position can be confirmed by the indicators.
(Lit: Enable; Off: Disable)



5. Fine-adjustment of the position

It can be adjusted by pressing  buttons.

- Press and hold the button and the position will move continuously until the button is released.

3. Adjust the temperature of the sole heater or turn it on/off.

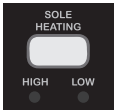
Just press the  button to change the temperature you like or turn on/off of the heater.

- Your attention: The sensed temperature varies depending on the body shape, massaged area, massage movement, clothing and ambient temperature.

6. To adjust the massage strength

Massage strength can be adjusted by pressing

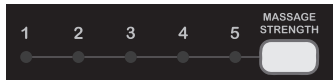

- Massage strength for the manual operation is displayed in 5 levels.

※ Caution:

Strength might increase drastically when the strength is increased in multiple steps.
The strength should be adjusted one step at a time based on the user's comfort.

How to Perform Air Massage in Manual Operation

Manual selection of air massage position

1. Press  to turn on the power

- When the unit has been idling for over 3 minutes without operation, the remote controller display will automatically shut down.

2. Press the AIR MASSAGE buttons on the remote controller to enable / disable air massage can be confirmed by the indicators.

Off/On for the air massage can be confirmed on the display. (Lit: On; Off: Off)

- See page 15 for details on air massage.



To adjust air massage strength

When performing the air massage, adjust by pressing  button.

- Strength is displayed in 3 levels.

Effective method for using the LEG/FOOT air massage.

Adjust the footrest so that your sole fits on it completely.

For a user with a small figure:

- Raise the footrest and it is easier to fit your sole on it.

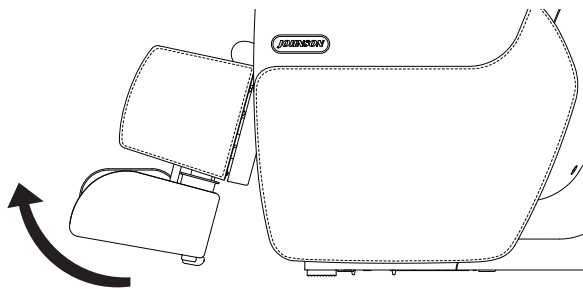

For a user with a large figure:

- Use your feet to push out the second section of the footrest.

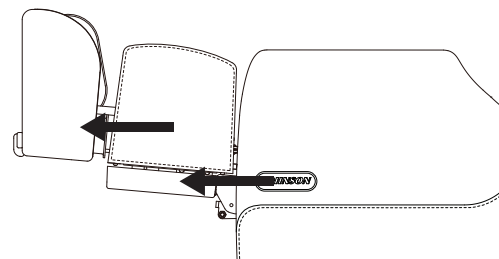

- Straighten your legs can extend the footrest, if you still need longer length, press the  to adjust till you feel comfortable.

After Completing the Massage

Timer Function

1. The massage will complete automatically in approximately 15 minutes after the start of operations.

- The knead balls will automatically move to the stored position while the backrest and the footrest will not for you to continuously rest in the angle you have previously adjusted.

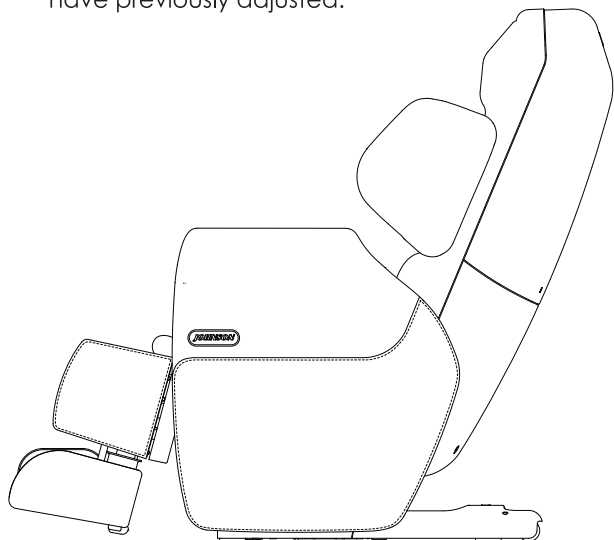

- Press  the backrest and the footrest will return to their stored positions, so you can get up easily and safely.

2. To interrupting the massage

Press  to move the knead balls, the backrest and the footrest to their stored positions.

3. If you experience any problems during use

Press the  (STOP) button.

- All operations will be immediately stopped.
- Get off the unit carefully to prevent the unit tipping over.

Returning to normal chair position

1. Put the large pillow back on.

- If necessary, place the small pillow under the large pillow for comfort. have previously adjusted.

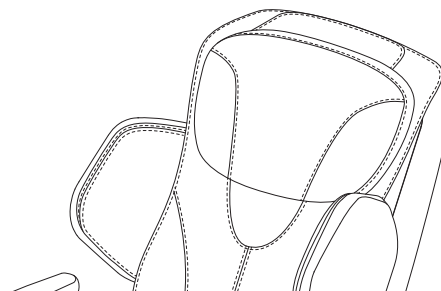

Disconnecting the power

1. Make sure the power switch is in the "O" (OFF) position.

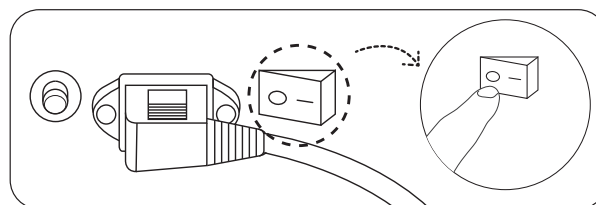

2. Remove the power plug from the power outlet.

Maintenance and Storage

To keep the appliance working and looking its best, please follow these cleaning guidelines once a week.

Areas covered with synthetic leather

For cleaning, wipe the unit with a dry cloth moistened in diluted neutral detergent and thoroughly wrung out, and then use a dry cloth to wipe the unit again. Thereafter, allow the unit to dry naturally.

(Excessive use of detergent may harm the synthetic leather surface).

Keep the unit clean and place it in a location with appropriate temperature and avoid moisture and dust.

- ※ Prior to the maintenance work, make sure to disconnect the power cord. Be careful that hands must not be wet to prevent electric shock or injury.
- ※ Do not use benzene, thinner or alcohol to clean the chair, nor spray any liquid containing any chemical agents to prevent the risk of electric shock or catching fire.

Main body

Use a dry cloth moistened with diluted neutral detergent and thoroughly wrung out to clean the plastics or the pipes, and then wipe with a dry cloth to completely remove the residual detergent.

- ※ Wipe the coated surface with a dry cloth.
- ※ Do not use benzene, thinner, alcohol, solvents or abrasives to avoid scratch, discoloration or cracks on the surface.

Remote controller

Use a dry cloth to clean the remote controller.

- ※ Never use a wet cloth for cleaning to avoid malfunction.

Back pad, pillow, seat cushion and other fabric parts

Wipe the parts with a dry cloth moistened in diluted neutral detergent and thoroughly wrung out, and then use a dry cloth to wipe the parts again. Thereafter, allow the parts to dry naturally.

- ※ Do not iron to prevent damage to the fabric.
Do not use benzene, thinner, or alcohol for cleaning, nor spray any liquid containing any chemical agents to prevent damage to the fabric.

Storage

After cleaning, keep the unit away from humidity. When the unit is not being used for a long period of time, place a cover over the unit to protect it from dust.

- ※ Do not place the unit in areas exposed to direct sunlight, or near heaters, hot air blowers or any other heating devices to avoid discoloration or deterioration on the surface of the holster.



Troubleshooting

You may experience the following noises or feeling when in massage, as being due to the mechanical design, they will not have any effect on the operation of the unit and the product life.

- A "clatter" noise occurs when the knead balls go up and down.
- A "creak" noise of the gear and the motor occurs while in massage.
- A friction noise occurs when the knead balls rub the cover cloth.
- A rattling noise occurs while in the "Tap" or "Knead and Tap" massage movements (particularly when the massage moves from the shoulders to the back).
- In the "Knead", "Tap", or "Knead and Tap" massage movements, massaging speed may vary with the knead balls' strength changed.
- A roaring noise of the motor occurs when load is given to the chair.
- A "cuckoo" noise occurs while in the auto mode course, the knead balls are automatically adjusted to the back-and-forth position to have the chair fitting in with the user's body shape.
- The compressor's noise and the air exhausting noise occur while in air-massage.
- A noise occurs when the air bag is inflated.
- A noise occurs while in massage of the shoulders.
- A grinding noise occurs when the backrest is reclined.
- There is a humming sound from the pump.

WARNING

Absolutely do not modify, disassemble or repair by yourself. Negligence may cause fire or mechanical trouble of the chair which may result in hazard on the body.

Problems	Check points	Troubleshooting
The unit does not start up.	Check whether the switch has been turned on.	Turn on the switch.
	Check whether the  button on the remote controller has been pressed.	Press the  button on the remote controller.
	No massage function has been selected.	Select a massage function.
	Check whether there is poor connection between the power plug and the receptacle.	Ensure good connection between the power plug and the receptacle.
Different height of the left and right knead balls.	A mechanism is used to allow two knead balls tapping alternatively.	This is normal and does not come from the trouble of the chair.
Sudden noise rises during operation.	Check whether the unit has been in operation for too long.	Turn off the power and stop the operation. Restart the unit after 30-min break.
Sudden cease of operation.	The rated operating time has elapsed.	Turn off the power and stop the operation. Restart the unit after 30-min break.
The reclined backrest fails to return its stored position when  is pressed.	Excessive use of the unit.	Turn off the power and stop the operation. Restart the unit after 30-min break.
	The rated operating time has elapsed.	
The power indicator fails to light up after the power switch is turned on.	Check whether there is poor connection between the power plug and the receptacle.	Ensure good connection between the power plug and the receptacle.
	Whether the circuit breaker is tripped off.	Restore the circuit breaker. If the problem re-occurs after the circuit breaker is restored, please contact our service center.

ATTENTION

- After checking, if the problem is caused by none of the above, switch off the power, unplug the power cord, and contact your dealer or our service center for repairs.
- Prior to operating the unit when it has not been used for a long period of time, read this manual carefully and make sure that the unit is still in good condition to avoid accident or injury.

Error display

Contents of the error will be displayed in the remaining time display area when an error occurs during the operation.



Error code display

Error Code	Contents	Handling
A0	Operation is terminated because there is a problem with the massage mechanism.	(1) Press STOP button. (2) Turn off the power switch, then restart the unit.
A1		
A2		
A3	Operation is terminated because the safety switch is actuated.	(1) Check and remove any foreign object which caused the problem. (2) Restart the unit.
B0	Operation is terminated because over load has occurred.	(1) Press STOP button. (2) Turn off the power switch, then restart the unit.
B1		
B2		
B3		
C0	HEAT function abnormal	Disable the HEAT function and contact our service center. ※Other massage functions are still good for use.
C1		
D0	For safety reasons, operation will terminate automatically when it cannot detect if someone is seated.	(1) Press STOP button. (2) After sitting down, press ON/OFF button to restart the unit.
E0	Operation is terminated because there is a problem with internal communication.	Please contact our service center.
E1		
E2		
E3		(1) Turn off the power switch, then restart the unit. (2) If the error code appears again after restarting the unit, contact our service center.
90	Operation is terminated because there is a problem with the remote controller communication.	(1) Turn off the power switch, then restart the unit. (2) If the error code appears again after restarting the unit, contact our service center.

※Please contact your dealer or our service center if the problem still persists after checking in accordance with this page. Service and maintenance will be carried out smoother if the error code is communicated when contacting.

Warranty and After-Sales Service

Consult your local store or dealer for details on warranty and after-sales service.

- **Warranty Period**

Please refer to the enclosed warranty card and verify the contents and the company/dealer's seal and carefully read the contents. Keep the warranty card in a safe place and present it for maintenance.

Authorized Service

If any abnormal condition persists after checking in accordance with trouble shooting page, stop using the unit, switch off the power, unplug the power cord, and then consult your local store or dealer.

- If the warranty period has expired, consult your local store or dealer for details on authorized service. If appropriate service can be provided to maintain functions of this product, repair will be performed at the user's cost.
- If you have any questions, please consult your local store or dealer.

Specifications

Product name		Massage chair
Model No.		MC-J5800
Generic name		Electric massage chair for home use
Rating	Power supply (50 / 60Hz)	AC110V/120V/220V/230V/240V
	Rated Time	30 minutes
Mechanical (knead balls) massage speed	Knead (cycles/min)	Max. approx. 33 cycles/min
	Tap (cycles/min)	Max. 650 cycles/min
	Up-and-Down	Max.60 mm/sec
Air pressure for air-massage		Approx. 30 ~ 35 kPa
Massage strength		5-level adjustment
Air strength		3-level adjustment
Auto-timer		Approx. 15 minutes
Reclining angle	Backrest	Approx. 115° – 160°
	Footrest	Approx. 8° – 88°
Dimensions (Approx.)	Backrest not reclined	1400 D x 1250 H x 790 W (mm)
	Backrest reclined	1860 D x 750 H x 790 W (mm) (with footrest raised in highest position)
Weight		Approx. 95 kg
Cover cloth		Synthetic leather
Country of origin	China	

※ Do not use the massager on other than the designated voltage.