

APEX

Apex Massage Chair

AP - Ultra

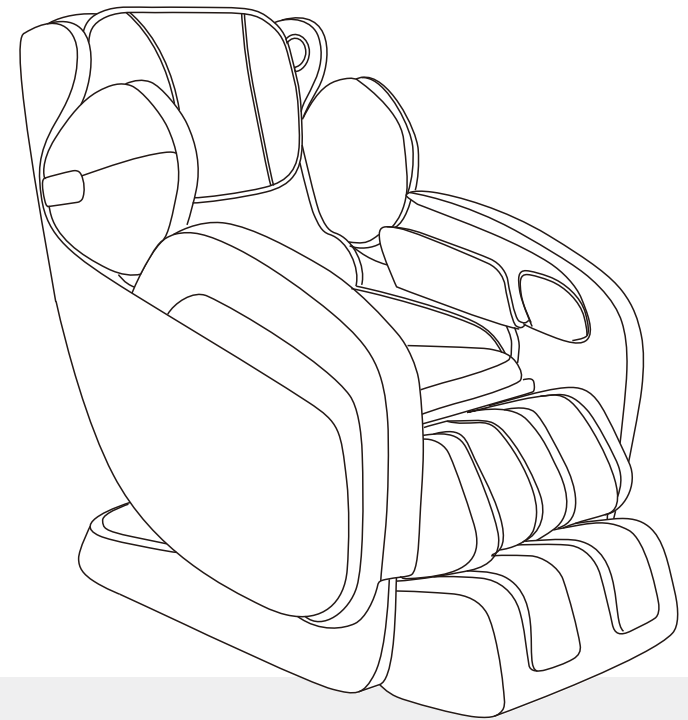

User Handbook

MADE IN CHINA

MAINTENANCE

CONTENTS

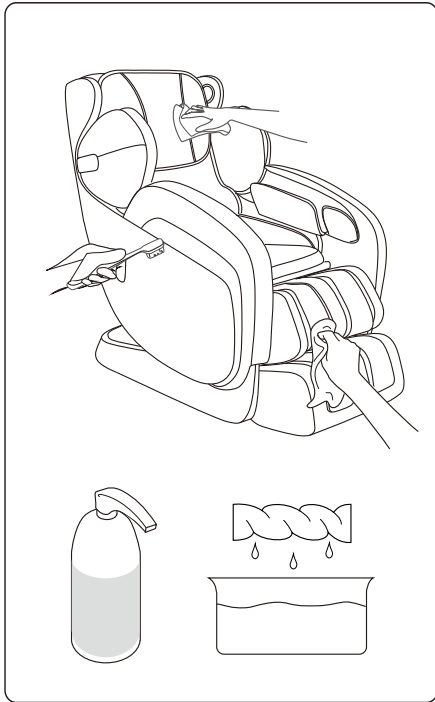

- Unplug the power plug before cleaning.
- DO NOT pour any liquids directly on to the chair. Spray or dampen the cleaning cloth.
- Use a non- toxic cleaner and dry cloth to clean the chair. The alternative would be to use a damp cloth using water to wipe down the chair.
- Be sure the chair is completely dry before plugging the power plug back in to the outlet.

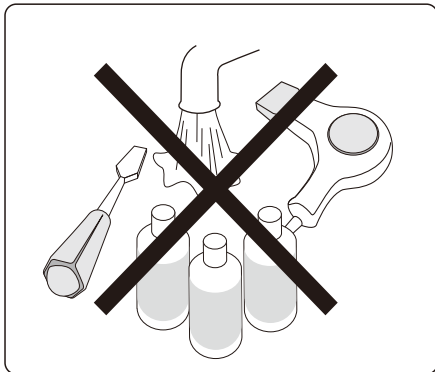

- Do NOT use any drying machines like a blow dryer to dry out the areas cleaned. Only air dry to avoid any damage to the chair.
- Do NOT use any products containing benzene or alcohol to clean the chair.

Thank you for purchasing the APEX Ultra massage chair. Its innovative and advanced features provide a wide array of different massages to satisfy most of your massage needs. Please read all the safety and operational instructions prior to using the chair.

Safety Instructions	2
Product Specifications	4
Product Components	5
Chair Installation	7
Remote Controller	9
Operation Guide	10
Troubleshooting	15
Maintenance	16

SAFETY INSTRUCTION

**The plug must be fully inserted into an appropriate outlet.
 Failure to do so may lead to serious injury and electrical shock.
 Do not modify the plug or remove the ground which may damage the chair.
 Prior to using the chair please read all the operational and safety guidelines.**

1. please ensure that the plug is inserted into the proper outlet
2. Make sure that the power plug is securely inserted into the proper outlet to reduce the risk of short circuits and fires
3. Always unplug the power from the chair before cleaning.
4. Do not this chair outdoors or by any heat producing areas such as fire place, windows heater,etc. This way cause the chair to breakdown and the warranty would not be valid.
5. Do not place this chair near or in areas with high humidity.
6. This product should always be placed in an area that is room temperature.
7. Do use this chair if you see damage to the power cord or if you see any moisture oin the chair or cord.
8. If you have any health conditions or are handicapped please consult with your physician if you can use this product.
9. No children under 18 should use this product unless your doctor recommends its.
10. Do not sleep in this chair while getting a massage to avoid any physical injury.
11. Do not use this chair more than 20minutes a day. Monitor your conditon daily for any muscle or body pain. if you find the there is pain or discomfort please refrain from using the chair and see your doctor.
12. Do not pull on the power cable, this may cause electrical damage.
13. Do not stand on the chair or apply acceding weight on the armrests.
14. When moving the chair please follow the instructions to avoid structural damage.
15. When using the chair please be sure there are no children or pet(s) nearby, behind of front of the chair. when the chair is in motion the chair may seriously injure the pet(s) or children
16. Do not modfiy or work on the chair which will void your warranty. Only professional and approved technicians should work on this chair.
17. This chair is for personal use only and should not be used for commercial using.

TROUBLESHOOTING

If abnormal sounds or movements are observed, please power off the massage chair by turning off the main power switch, and removing the plug from the electric outlet. Please contact the customer service department for further assistance.

Problem	Solution
The massage chair is connected to power but is not functioning.	1. Check to see if plug is inserted properly, or if power outlet is functioning properly. 2. Check to see if the main power switch is in the "ON" position.
The remote controller is responding, but the massage chair is not functioning.	The massage chair may have automatically shut down due to overheating protection devices. Please turn off the power and allow the chair to cool off for 30-50 minutes.
Both the remote controller and massage chair are not responding.	The massage chair automatically goes into idle mode when a massage program is completed. Please press the power button again to turn on the chair.

OPERATION GUIDE

SAFETY INSTRUCTION

4 After use

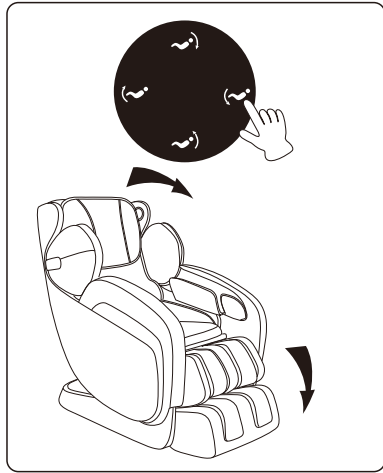

1. After the massage program is completed, return chair to upright position by pressing the Recline Angle Adjustment button.

- Please survey surrounding area prior to adjusting the recline angle, paying special attention to children or pets that may be in close proximity.
- Please make sure your arms and legs are away from gaps between the armrest, legrest, and footrest, to prevent any possible pinching or injury.

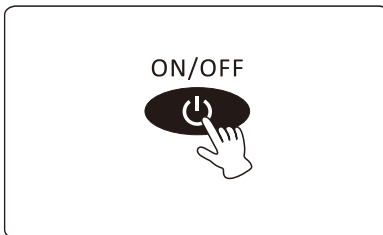

2. Press the power button to power off the massage chair and return remote controller to the storage box.

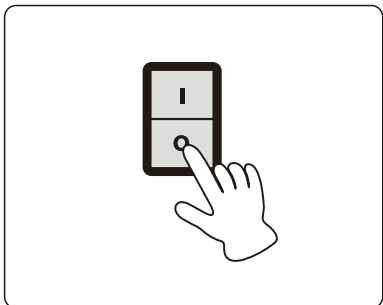

3. Turn off the main power switch.

4. Remove plug from power outlet.

- * Please do not pull on the power cord to remove the plug.
- * Please do not unplug with wet hands.

18. Always check whether the surface of the massage chair is torn or ripped before usage, if you find any unfamiliar rips in any area of the cloth in the backrest, do not use the massage chair, kindly contact the service centre immediately for repairs.
19. This appliance is designed for household use only.
20. For those suffering from illnesses, please consult your doctor for advice prior to use.
21. Please do NOT use if you have a heart condition or have a pacemaker.
22. If you experience pain during usage, stop using the massage chair immediately, if any injuries occur, seek medical treatment immediately.
23. Never massage the swollen or inflamed parts of the body.
24. This product is non-professional appliance designed to provide a comfortable massage. Do not use this product as substitute for medical treatment.
25. Each massage session should not exceed 30 minutes. Massage the targeted area only for 15 minutes, Over-massaging can lead to overheating, thus giving the appliance a shorter lifespan.
26. Do not operate where aerosol(spray) products are used or where oxygen is being administered.
27. The massage chair is not suitable for children aged 12 and below.

NOTE:

This appliance is not intended for use by persons (including children) with reduced physical sensory or mental capabilities, or lack of experience and knowledge, unless they have been given supervision or instruction concerning use of the appliance by a person responsible for their safety.

Children should be supervised to ensure that they do not play with the appliance.

If the supply cord is damaged, it must be replaced by a special cord or assembly available from the manufacturer or its service agent.

The appliance heats up during operation. Persons sensitive to heat must take extra caution when using the appliance.

PRODUCT SPECIFICATIONS

Description	Specifications
Product Name	Apex Massage Chair
Model No.	AP-Ultra
Rated Voltage	120V~
Rated Frequency	50/60Hz
Rated Power Consumption	230W Max.
Dimension (LxWxH)	1400x760x1280mm
Weight	Net Weight: 110Kg Gross Weight: 122Kg

OPERATION GUIDE

3 Display Diagram

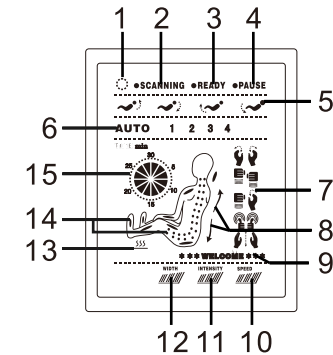

1. Massage chair is powered on.
2. Massage chair is scanning the back contour and preparing for initiation.
3. Scanning is complete and ready for massage programs.
4. Pause button has been pressed and chair is temporarily stopped.
5. Reclining position adjustment buttons are pressed and the backrest and /or legrest are moving.
6. Displays which automatic program is activated.
7. Displays which massage technique is activated at the time. In order from left to right: Kneading, Tapping, Dual, Shiatsu, Rolling.
8. Depicts the direction of the massage rollers, moving upwards or downwards.
9. Cheerful greeting from your massage chair.
10. Shows the massage speed level, from one bar to three bars illuminated.
11. Shows the air intensity level, from one to three.
12. Shows massage roller width, from narrow to medium to wide.
13. Heating function is on.
14. Displays the location of massage rollers and active air bags.
15. Depicts time remaining in current massage program.

OPERATION GUIDE

Annular functional area

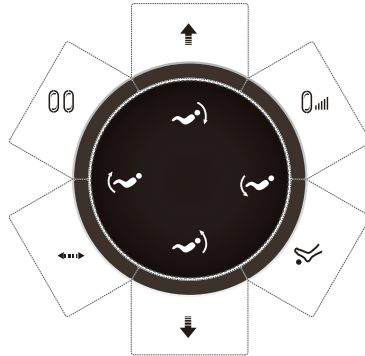

This is the pressure position button. Each time you press the button, it will change the area the air massage is concentrating on.

Shoulder->Arm->Leg->Arm+Leg->Leg+Arm+Leg->Off

This button allows for you to control the intensity of the air bag on 3 different intensity levels.

Press this button to turn on/off the foot roller function.

Roller Location Adjustment: Hold the up or down arrow to move the massage rollers to the desired location.

Width: Press to adjust massage roller widths from narrow to medium to wide. Width adjustment is not available in kneading mode.

: Press the button and hold on to adjust the footrest independently.

: Press the button and hold on to adjust the massaging position of backrest or legrest.

PS: The position adjustment button have no function when the chair in the stretch program

PRODUCT COMPONENTS

Main Body Diagram (Front)

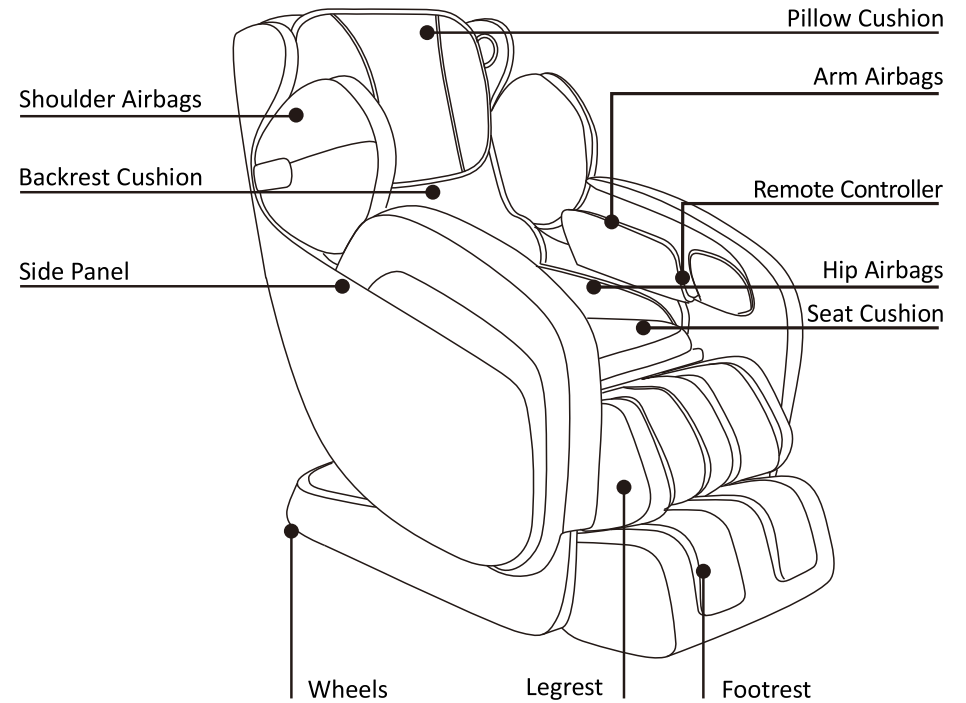

The rotatable footrest-design with rotatable footrest to massage the knee (heating & air bag pressing)

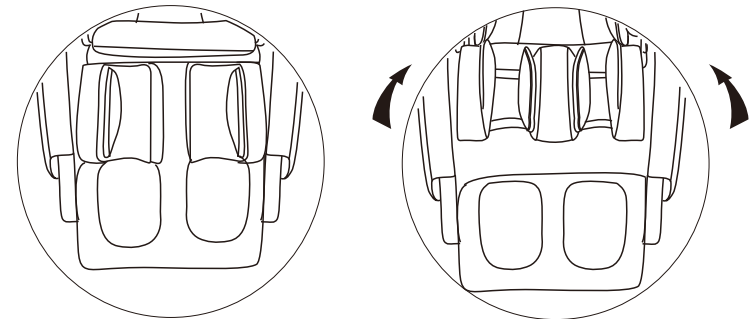

PRODUCT COMPONENTS

Main Body Diagram (Rear)

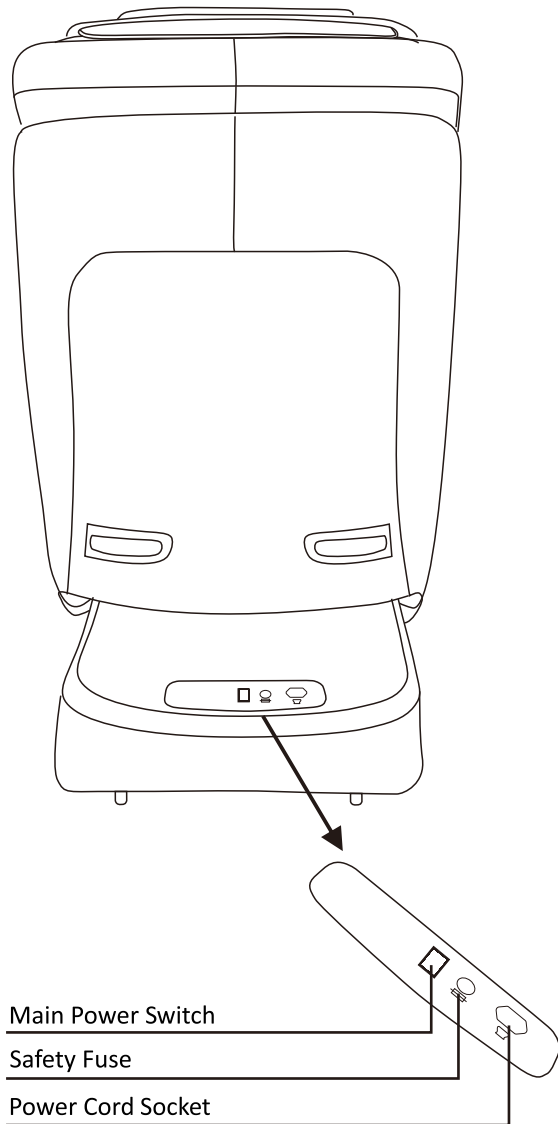

OPERATION GUIDE

Manual mode



: Manual massage technique button,
 Kneading -> Tapping -> Dual -> Shiatsu -> Rolling -> Off



Speed: Tapping & Kneading & Dual Action & Shiatsu Speed adjustment
 (3 levels)



“Area Adjustment Button” In manual mode, press to select between
 specific areas in the following order:
 Back -> Waist -> Seat -> Back & Waist -> Waist & Seat -> The whole body



“Fixed Spot Massage” Press to stop the rollers at a particular area for
 a fixed point focal massage in manual mode.



: Stretch function.



3D foot massage auto mode: switch on/off the foot massage auto
 mode function.



Heating: Switch on/off for back heating function

OPERATION GUIDE

2 Function description of Controller buttons.



: Start or Stop massage chair

Press this button, massage chair will be ON, screen will be ON, User can choose auto or manual function to massage.

Press this button again, massage chair will be off, massage stopped, massage chair will come back to the original position, all buttons are inactive. When the chair returns to the original position the chair will completely shut off.



: Press to temporarily pause the massage, chair will enter idle mode. Press again to resume massage.



: Press the button first, massage back and leg position to zero G1, press second, the position to zero G2, press third, the position to zero G3, press fourth, massage chair return to original position.

Zero G1 -> Zero G2 -> Zero G3 -> Original Position

PS: The position adjustment button have no function when the chair in the stretch programme

Auto mode:



: Intelligent Automatic Programs: Press once to initiate the first of four intelligent automatic programs. Press repeatedly to switch between the programs, which are sequenced as follows:

Deep Tissue -> Relax -> Rejuvenate -> Stretching -> Off

CHAIR INSTALLATION

1. Remove the package and get out the spare parts

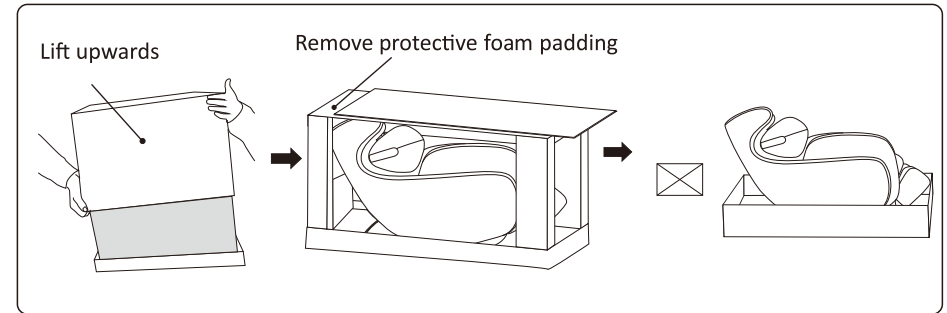

- 1) Remove the carton.
- 2) Take out the foam.
- 3) Install the Pillow, backrest cushion, cushion, spare parts.
- 4) The spare parts include: remote control, holder, user manual, wheel, power cord.

2. Place the massage chair in an open area

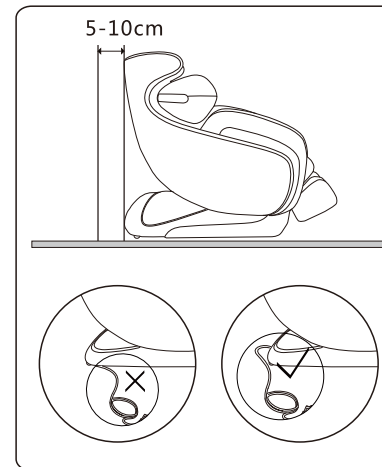

- Allow sufficient space around the chair for recline purposes.

5-10cm distance for the back side and 50cm in front of the footrest.

***To avoid the damage of the floor and to reduce the noise, please put area rug under the massage chair.**

***Make sure that there are no barriers at the front and the back of the massage chair.**

***Please do not put it in wet or uneven floor.**

***To avoid signal interference, please place it 4 feet away from AV,TV, and radio.**

CHAIR INSTALLATION

3. Moving the massage chair

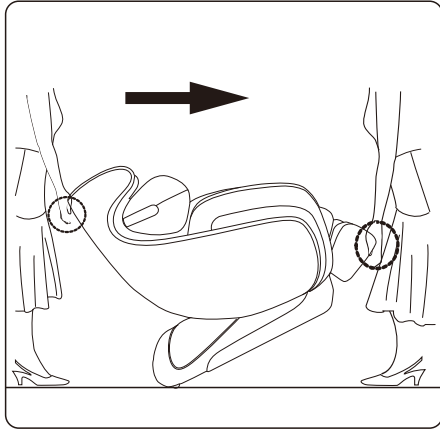

1. As illustrated, push the backrest downwards and tilt chair on to its wheels at a 45° angle. Slowly push and maneuver the massage chair to desired location. Lower massage chair slowly and smoothly until it is fully flat on the ground.

- * Do not move massage chair when occupied or in use.
- * Moving the massage chair may cause damage to floors. Floor protection is recommended (e.g. rugs, carpet).
- * Do not drop or suddenly let go of the chair when moving as it may damage the chair.
- * Two person participation is recommended. Please use extra care when handling the massage chair.

REMOTE CONTROLLER

1 Remote Controller

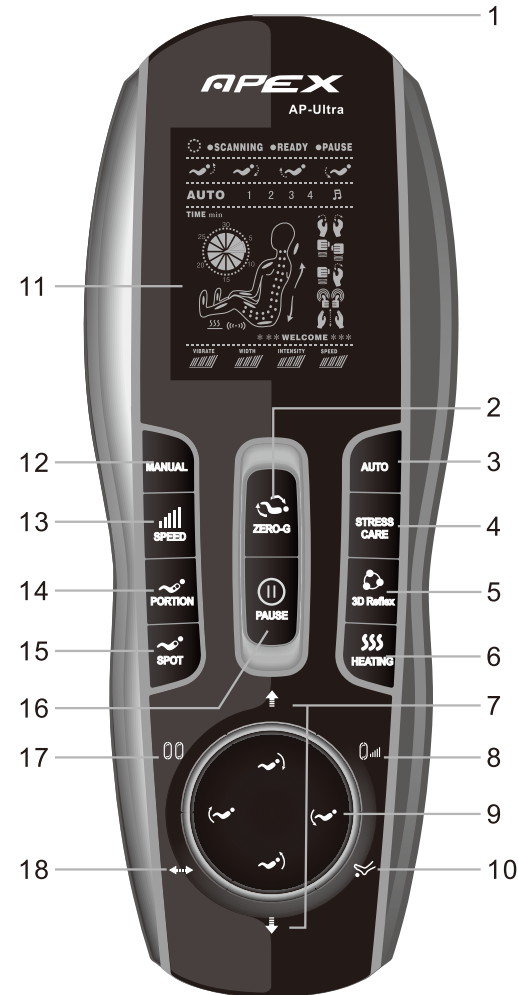

1. On/off Massage Chair
2. Zero Gravity Button
3. Auto Mode
4. Stretch
5. 3D foot massage auto mode
6. Heating Button
7. Position Adjust Button
8. Air Massage Intensity
9. Recline Adjustment
10. foot roller Button
11. Display
12. Modes Of Manual Programme
13. Speed Adjustment
14. Area Adjustment Button
15. Fixed Spot Massage
16. Pause/emergency Stop
17. Air Pressure Button
18. Roller Width