

KAHUNA  CHAIR®

KAHUNA MASSAGE CHAIR
SM9300
MANUAL





CONTENTS





Please read and follow all safety instructions listed in this user manual prior to use. Basic precautions should always be considered when operating an electrical appliance.

Safety Instructions	2
Product Components	7
Chair Installation	10
Remote Controller	15
Operation Guide	23
Maintenance	24
Troubleshooting	25
Product Specifications	26



- Please read this manual carefully to make sure the installation and operation of the massage chair is done correctly.
- "Safety Instructions" are provided for important safety information. Both Warning and Caution are important safety caution, please be more cautious.

	Warning	This sign indicates warning of causing possible death or injury to body.
	Caution	This sign indicates caution of causing possible pain or damage to body.

	This sign indicates forbidden behavior.
	This sign indicates must follow instruction to operate.
	This sign indicates self disassembly is forbidden.
	This sign indicates correct operation of cable.

- The following should be kept for any further references.

SAFETY INSTRUCTION



Warning

	<ul style="list-style-type: none"> • Osteoporosis patient ; • People with heart disease including embedded pacemaker or other medical electronic device inside the body ; • For pregnant women or people with health issues, please consult with doctor before use ; • Patients with a high fever forbid to use this machine. • Perceptual disabilities patients forbid to use this machine. • People over 80 years old forbid to use this machine. • Kids are not allowed to use the chair ; • Don't operate the chair after the use of alcohol. • Please don't sleep in the chair. • Don't use the chair when your body is wet. 	<p>People who are not suitable to use the chair</p>
	<ul style="list-style-type: none"> • Make sure there are no kids or pets or other objects around (under, behind or in front of) the chair at the moment of backrest, leg-rest up/down or leg-rest retraction/extension from reclining position. • During operation, if body is being abnormal, please stop the operation and go consult with your physician. • Please do not take strong massage on the head. • Do not massage belly or knees, be careful when massaging neck. • Children or pets are not allowed to play on the chair especially during massage. Standing or sitting on the back or armrest is not allowed either. • Those who move around with difficulty or can't express themselves must be taken care of strictly and continuously during massage. 	<p>Accident /injury</p>
	<ul style="list-style-type: none"> • Insert the plug of the chair into correct and suitable power socket. • Make sure the plug is completely inserted into the socket to reduce short circuit or fire risk. • Unplug the power when not in use, stop all massage functions and turn off on/off key before unplugging. 	<p>Fire and electric shock</p>
	<ul style="list-style-type: none"> • Massage cushions of the chair are not allowed to fold for storage. • The machine is forbidden for no-load running for a long time. 	<p>Accident</p>
	<ul style="list-style-type: none"> • Power cord, plug, socket can't be used in broken or loose contact condition. • Don't use other electric power except rated voltage in case of fire, electric shock or any breakdown. • Any broken, re-process, knotted, twisted power cord or pressed under heavy cargo is not allowed to use. 	<p>Fire and electric shock</p>



Warning

	<ul style="list-style-type: none"> If the chair is dysfunctional, or is broken, splashed with water or falls into water, please have it repaired by professional repairman or send the chair to assigned service agent. Self-modification, disassembly or maintenance is forbidden. If power cord or plug is damaged, please don't replace it yourself, please contact us or appointed dealer for replacement. To avoid electric shock or body injury, please don't open or disassemble any part of the chair, there is not any attached part of the chair for maintenance by customers. Check leather or cloth material on the back and other areas is broken or not. If broken, even though it is small, please stop using the chair, unplug the power and have it repaired. 	<p>Disassembly and maintenance</p>
--	--	------------------------------------





Caution

	<ul style="list-style-type: none"> Please operate the chair when it is flat or on leveled place 	To avoid sudden falling.
	<ul style="list-style-type: none"> Position the chair 4 inches from the wall to allow for sufficient space to recline up and down. 	To make sure the back lying.
	<ul style="list-style-type: none"> The maximum suggested operating time is 20 mins. 5 mins for each position beginning with the slight- step massage. Along continuous massage in the same position may cause uncomfortable feeling. 	Too long time massage is bad for your body.
	<ul style="list-style-type: none"> Before sitting on the chair to avoid injury please inspect everything to confirm that the massage heads are in the correct position. 	To avoid accidental injury.
	<ul style="list-style-type: none"> Please make sure that the power switch is on "OFF" position before inserting the plug into the socket. 	
	<ul style="list-style-type: none"> Turn off all controls before removing plug from outlet. 	To avoid the accident when turn on the power.
	<ul style="list-style-type: none"> Make sure the plug is completely inserted into the socket. 	
	<ul style="list-style-type: none"> Checking whether there are any damages on the wire and make sure there are no water or rubbish on the wire. 	To reduce short circuits and any fire hazard.
<ul style="list-style-type: none"> Installing the wire in a correct way. The plug must be inserted into socket with the connect, the connect couldn't be bent or cut off. 		To avoid electric shock in any leakage or breakdown.
	<ul style="list-style-type: none"> Don't use or store the chair in the wet environment like near the swimming pool, or bathroom. Keep the chair and remote control dry at all time. Don't use the chair when your body is wet. 	<p>To avoid leakage or electric shock.</p>

SAFETY INSTRUCTION

Caution

	<ul style="list-style-type: none"> • Don't press with hands or step on the massage heads with feet. • Don't put hands between the working massage heads. Don't put hands or feet in the gap of mechanical parts. Don't drop or insert anything into the slot of massage chair. • Don't stand or sit or put anything on the backrest, armrest, or leg-rest. • Don't stand on the chair during operation. Don't move the chair during operation. • Don't pull out the plug or turn off the power during operation. Don't put your hands or head between leg-rest or beneath. Don't use the massage chair while wearing hair ornaments. Don't put hard things in pocket when take buttocks and huckle massage. • Don't sit or press on the backrest when the chair is in reclining position. • Don't use on bare skin or wearing thin clothes, thin clothes may cause better massage effect, But it also may cause irritation to the skin or cryogenic burns. 	<p>To avoid accidents or injury</p>
	<ul style="list-style-type: none"> • Keep the chair away from heat, wet, sharp things and corrosive, inflammable, explosive environment. • To use electric blanket or other heating products on the chair is forbidden. • Don't put in the space of dust serious or corrosive gas environment. • Don't put the chair in a small space places or use in the bad air circulation places. 	<p>To avoid fade, discolor on upholstery or hardened, deteriorated on PU.</p>
	<ul style="list-style-type: none"> • Keep the chair away from stove or other heating products. • Don't put the chair directly under the sun or other high temperature places. • Don't use the chair in outdoor. 	<p>To avoid electric shock.</p>
<ul style="list-style-type: none"> • Make sure to install the wire in correct way(Incorrect install way may cause electric shock. If you don't know how to install, please find a professional electrician) • Don't use plug adapter (If the enclosed plug doesn't match with socket, please don't change the plug by yourself and find a professional electrician to install a matched socket.) 		

Caution

	<ul style="list-style-type: none"> • Unplug the power before cleaning the chair. • Unplug the power after using the chair. 	To avoid electric shock or fire hazard.
	<ul style="list-style-type: none"> • Unplug the power when any damage on the power. 	
	<ul style="list-style-type: none"> • Hold the plug to unplug the power but to not try to pull the wire to unplug the power. 	To avoid accidents
	<ul style="list-style-type: none"> • Please turn off the power switch and unplug the power after massage. 	
	<ul style="list-style-type: none"> • Unplug the power immediately when electricity goes off. 	To avoid damage or accidents when power on again.



- Warning :
- 1.Do not use it when wet.
 - 2.The disabled may need supervision.
 - 3.The chair has heat function, people who are insensitive to heat must pay high attention.

| Grounding instruction |

The chair is equipped with a cord having a grounding conductor. The plug must be plugged into an appropriate socket that is properly installed and matched with the plug.



Earth wire is not allowed to be in these places

Gas pipe: probably cause explosion or fire.
 Phone wire and lightning rod: probably cause electric shock and fire when thundering.
 Water pipe: earth wire is useless where there are plastics

PRODUCT COMPONENTS

| Main body diagram (Front) |

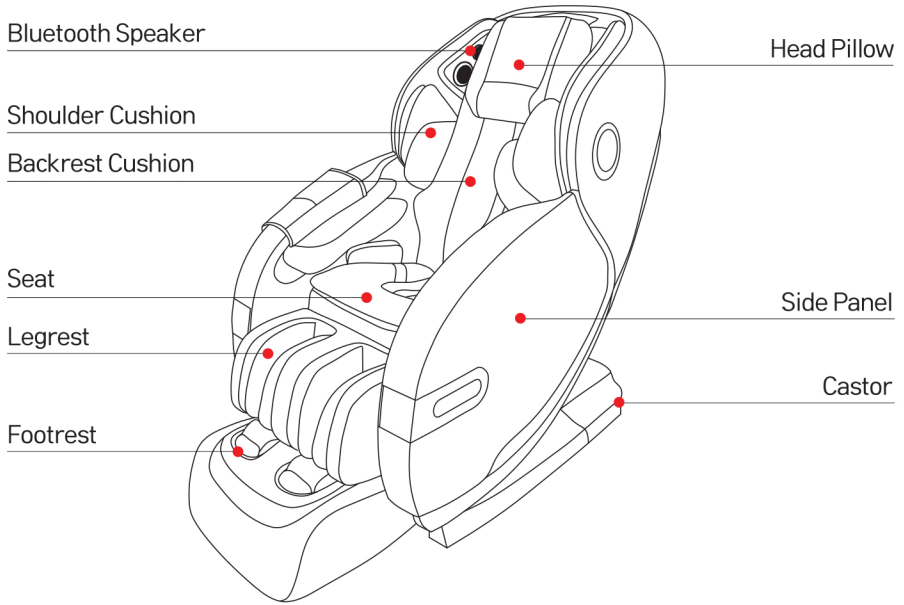

| Main Body Diagram (Rear) |

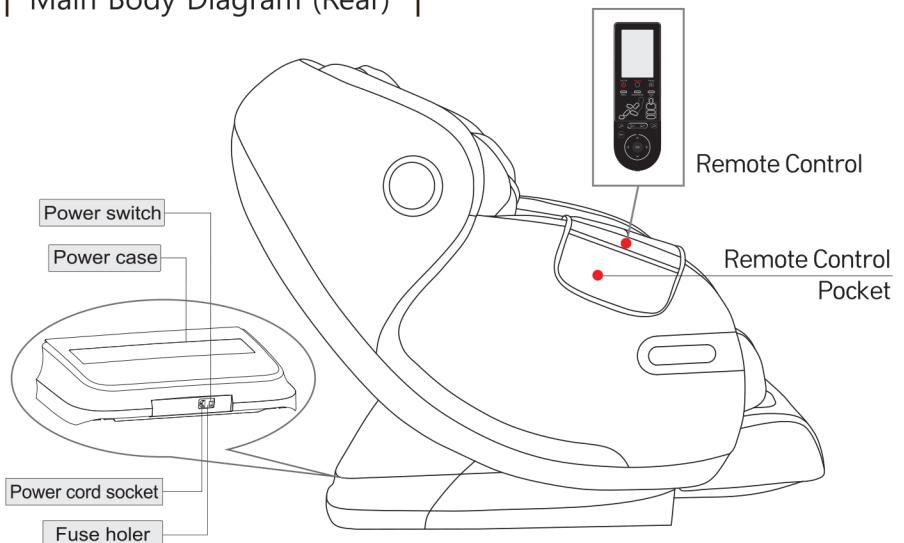

| Internal Structure |

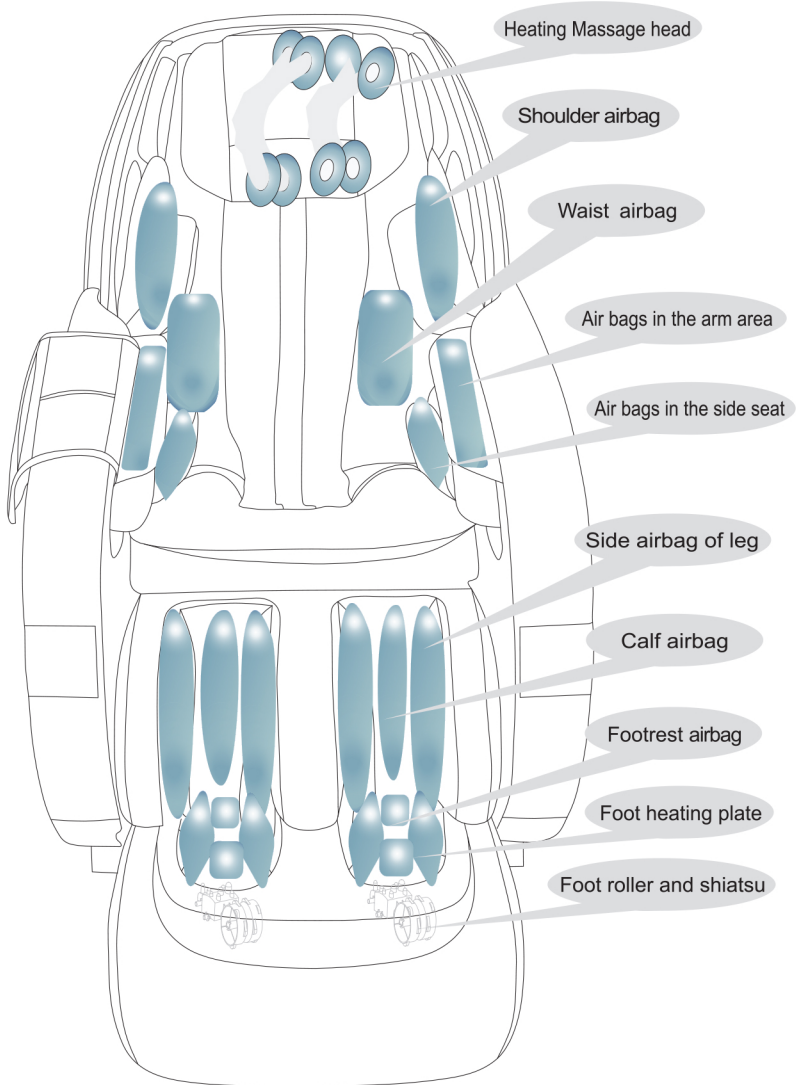

PRODUCT COMPONENTS

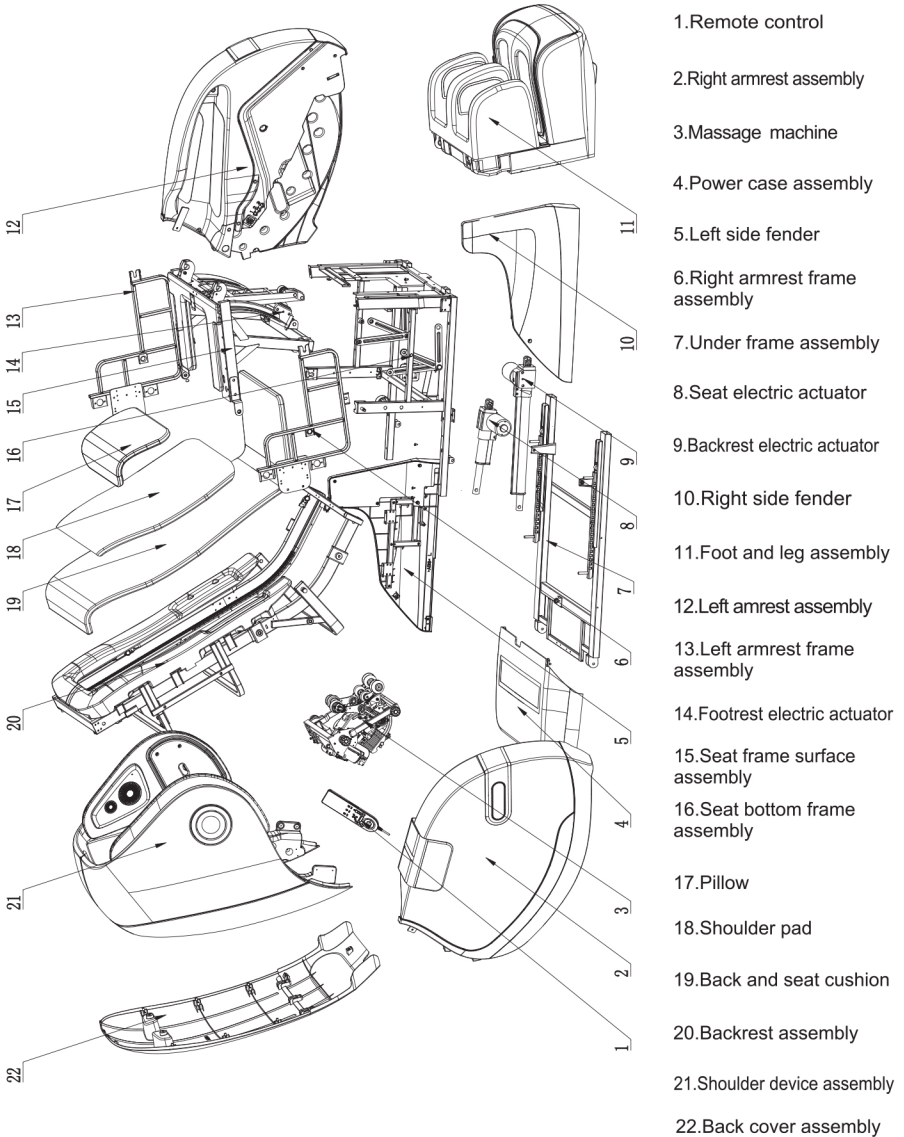

CHAIR INSTALLATION

1. Remove the package and take out the chair parts and components

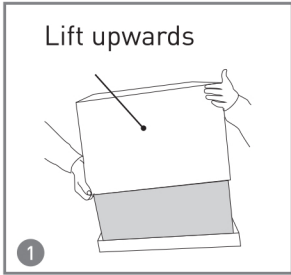

Remove the carton.

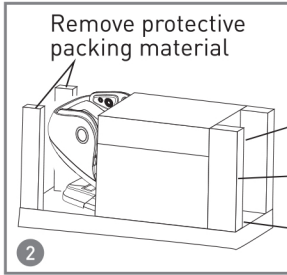

Take out the packing material.

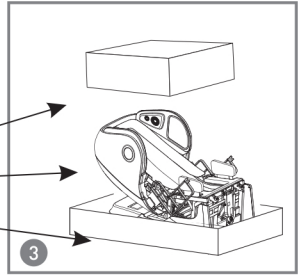

Take out all parts including component list below with seat cushion and pillow.

*The spare parts include: remote control, holder, user manual wheel, power cord.

Components

1. A screw driver and Allen-wrench is needed to complete installation.
2. Allen wrenches are included in the parts bag, but you will need a screw driver as well.
3. Please remove Velcro-cover when you attach Velcro.
4. Extra Foot Paddings for softer foot massage are included for personal preference.

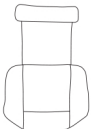

Head pad



Controller bag

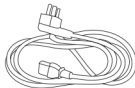

Electric power cable

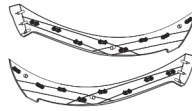

The left /right armrest exterior parts

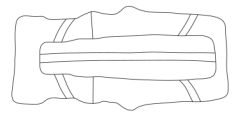

Back seat cushion



Shoulder cushion

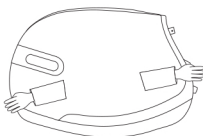

Left armrest

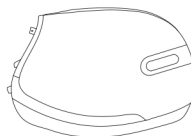

Right armrest

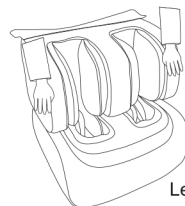

Legrest device

CHAIR INSTALLATION

2. Install the legrest

1. Unscrew the bolt from hanger of legrest.

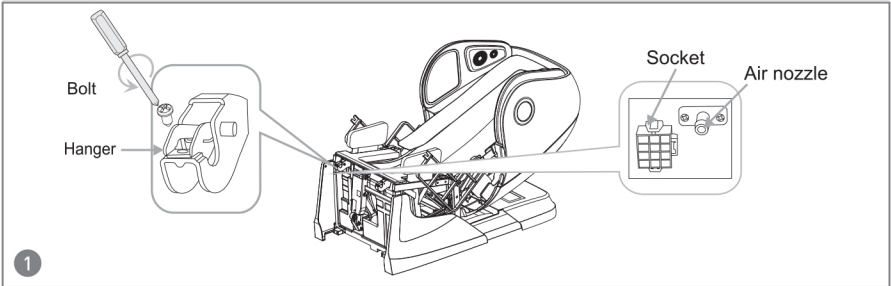

2. Connect the legrest's air hose with the corresponding air nozzles of the main body tightly.

3. Connect the cable plug and the socket.

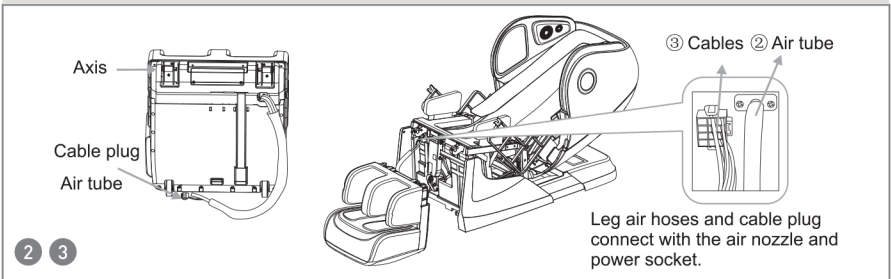

4. Raise the rotation shaft board on hangers, raise the legrest with hands, put rotation shaft into hangers on main body, and put rotation shaft board down.

5. Screw it back tight.

6. Connect the legrest leather piece with seat by velcro.

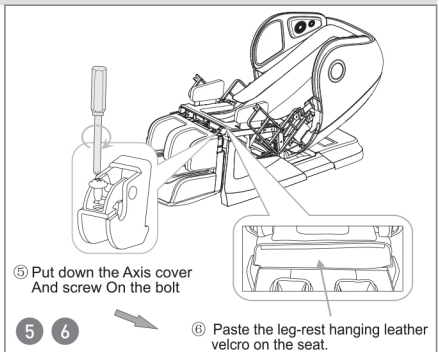
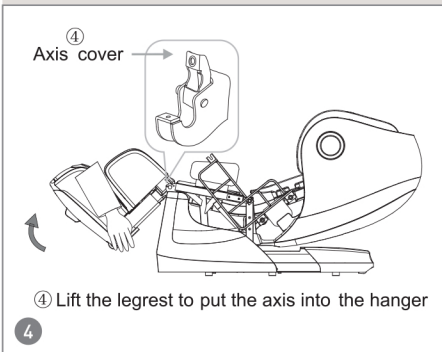

Attention: When connecting the air pipe and cables, don't twist the air pipe and cables together.

CHAIR INSTALLATION

3. Install the side arm panel |

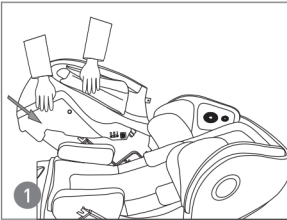
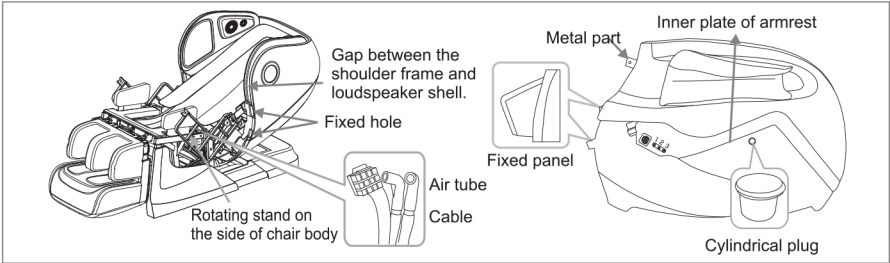

1 Lift the front armrest and push the cylindrical plug into the rotating stand on the side of the chair body and push back.

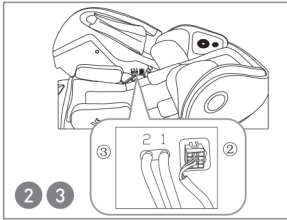

2 3 Put the cable plug into the connector.

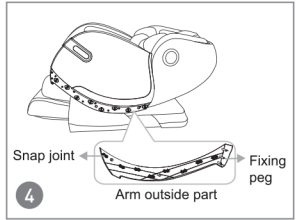

4 Insert the 3 fixing peg of the arm outside part into the 3 fixing holes of the front bottom armrest, and buckle 8 snap joints in place.

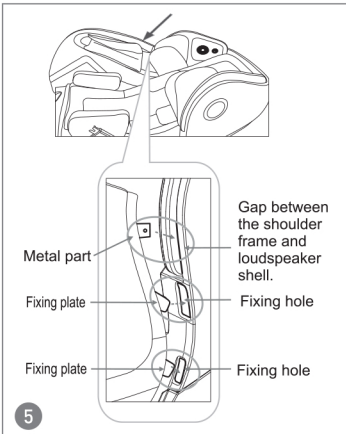

5 Insert the 2 metal fixing part of the back armrest into the fixing hole on the back main body, and insert the upper fixing part into the gap between shoulder frame and loudspeaker shell.

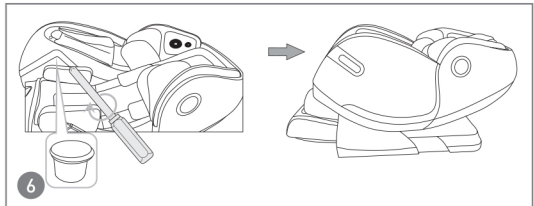

6 Remove the rubber plug of the armrest, spin the screws inside the hole tightly then put on the rubber plug tightly.

Reminder : when installing the left armrest, there's no cable, only install the air tube is ok.

CAUTION

Do not squeeze the air tubes during the installation. This may cause air leakage or the air bags not inflatable. Please make sure that the fixed plate and wire need to be plugged firmly, otherwise the armrest may drop or USB can't charge.

CHAIR INSTALLATION

4. Install the controller and the seat cushion

1. Insert the Velcro of remote control pocket through the upper position of arm airbag installed in right armrest, paste it on another Velcro.
2. Put the remote control in remote control pocket.
3. Align the dent part of the wire to the protruding point of the socket on the right part of seat, connect the plug and socket, and tight the nut.

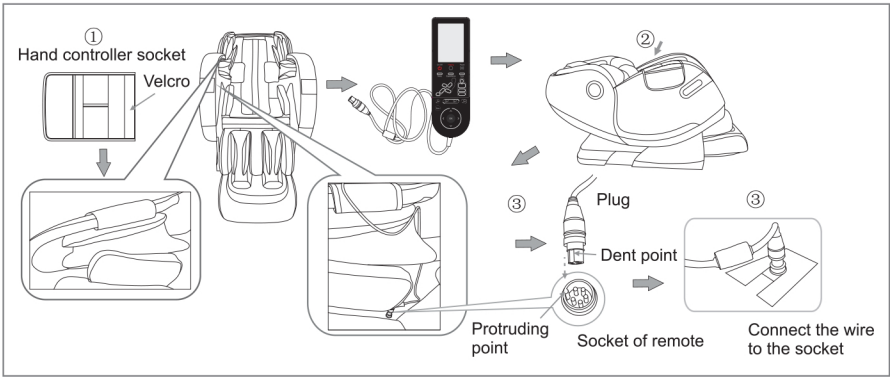

Put the back seat cushion, shoulder cushion, head pad onto the backrest and connect the two parts with zipper and velcro.

★ Warm tips

In order to get exact correct body test data for comfortable massage effect, when you sit on the chair, please make the bottom rim of the head pad flush with your ears before zippering the said two parts.

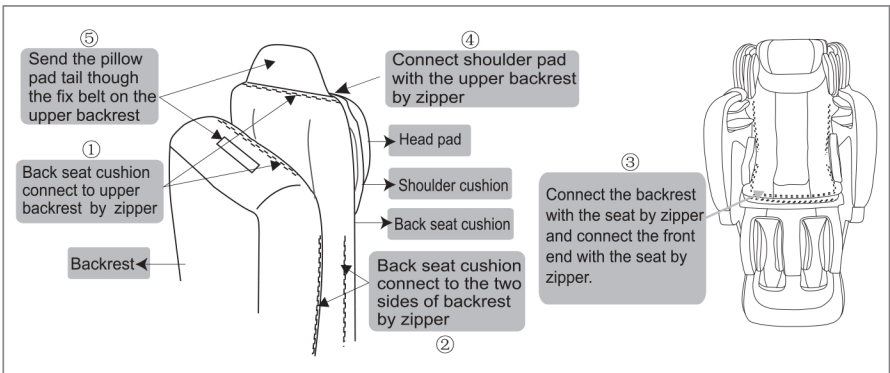
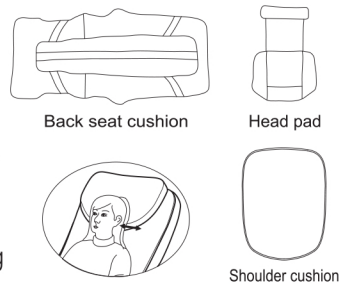

5. Moving the massage chair

After completing the installation, put the chair in incline / upright position to move the chair easily.

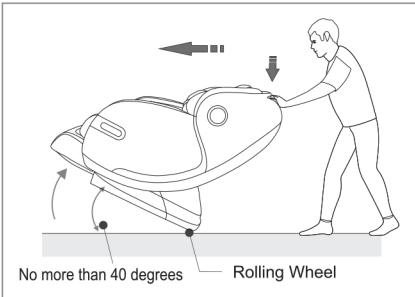

- As illustrated, tilt the chair back onto its wheels at 40° angle. Slowly push and maneuver the massage chair to desired location. Lower massage chair slowly and smoothly until it is fully flat on the ground.

6. Place the massage chair in an open area

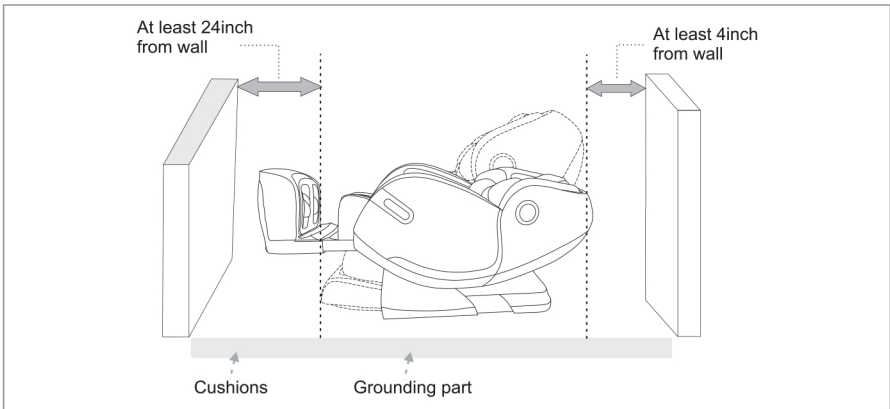

Because the chair is heavy, it may ruin your floor in long time setting. Please put a blanket or other soft things to protect your floor.

CAUTION

- * Don't use the chair in wet places like near swimming pool , bath room to avoid leakage or electric shock.
- * Please use chair in flat place to avoid chair falling or noise or other unexpected trouble.
- * Don't use under sunlight or near stove or other heating place to avoid upholstery deteriorated.

REMOTE CONTROLLER

| Remote Controller |

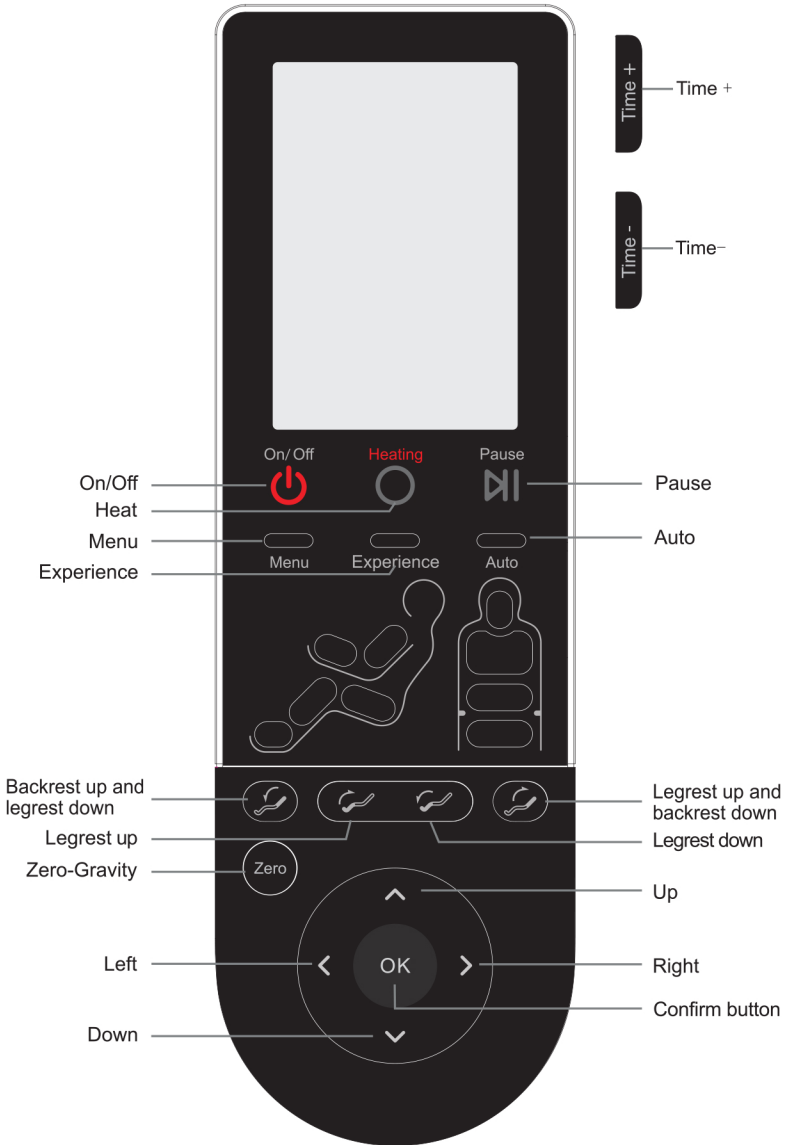

| Function description of Controller buttons |

On/Off



In standby status press ON/OFF key , the massage chair go into ON status, then press Menu key or other key to choose any auto massage program, the massage machine will detect shoulder height and start to massage, In ON status, press the ON/OFF key, the massage chair will turn off and return to original status, the legrest goes down to the lowest position, the backrest raise up to the top, the controller turn off in 3-5 seconds.

Heating



In the boots status, press this button to control the heating switch.

Pause



In the boots status, press this button to stop all the on-going massage immediately, all the button will not working, press this button again, the massage will recovery.

Menu



Press this button in Main interface to switch to menu interface, user can set different function for massage chair. Press it in Menu interface to return to main interface.

Experience



In on status, press this key to enter the "Office person" automatic massage program. Default work time is 8 minutes.

Auto



In ON status, press this key each time to change one kind of auto program, there are the following program for choice, "Recovery", "Relief", "Yoga Stretch", "Renew", "Music Sync", "End of Day", and "Stop" mode. There is relative status screen display.



Keep pressing this button, backrest goes up, legrest goes down, release it, backrest and legrest stop moving. Controller screen will show position adjusting when adjusting the position of massage chair.



Keep pressing this button, legrest goes up, release it, legrest stop moving. Controller screen will show position adjusting when adjusting the position of massage chair.



Keep pressing this button, legrest goes down, release it, legrest stop moving. Controller screen will show position adjusting when adjusting the position of massage chair.

OPERATION GUIDE



Keep pressing this button backrest go down legrest go up release this button, backrest and legrest stop moving. When adjusting sitting position, it shows seat position adjusting in controller screen.



In the boot status, press this button, the massage chair adjust into zero gravity status: it has 3 angles, 3 degrees. Zero gravity will cycle in turn.



There are four direction buttons: Up, Down, Left and Right. In the menu interface, it is used as a navigation key: press Up and Down to quickly browse the menu, and press Left and Right key to go to previous and next menu. In manual mode, the Up and Down key can also be used to adjust massage roller position in body scanning and fixed point massage.



In ON status of menu mode, press this button to confirm to choose menu item or pop up at the next menu.



In ON status, press time + or time - button to adjust the massage time, it has following time for choice: 10 minutes, 20 minutes and 30 minutes. Press time + to make the massage time longer until 30 minutes, no more to add. Press time - to make the massage time shorter until 10 minutes, no more to reduce.

Display diagram

Main interface

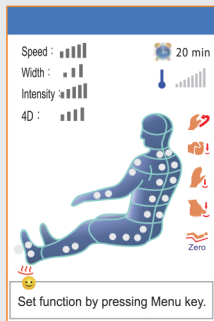

Press “on/off” button when power is on, a buzzer beeps once short and brittle. LCD screen display boot screen, after 2-3 seconds it displays the main interface and enter standby mode. Main interface show message position, method, time, current message status etc., all information will be updated timely when the chair start working.

- Message function
- Kneading
 - Tapping
 - Knocking
 - Shiatsu
 - Zero gravity
 - Massage time left



Massage position

- █ █ █ █ █ Message speed(Level 1, 2, 3, 4, 5) Status Display
- █ █ █ █ █ Message width(narrow, mid, wide)
- █ █ █ █ █ Air Intensity (Level 1, 2, 3, 4, 5) Status Display
- █ █ █ █ █ 4D (Level 1, 2, 3, 4)

Temperature Level of Massage Machine Heat

Heating

Menu interface

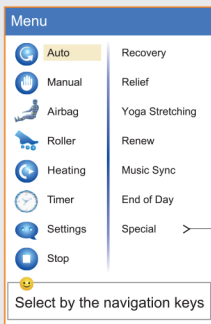

Press the "menu" button in the main interface, it will switch to the menu interface, user can set all message function. Press the "menu" button in the menu interface will exit and return to the main menu interface.

Auto Mode : Press Menu, select auto mode among “Recovery”, “Relief”, “Yoga Stretching”, “Renew”, “Music Sync”, “End of Day” by pressing OK. And Special mode includes six programs: Office Person, Powerful day, Golfer Mode, Senior Mode, Dynamic Sports, Healing.

- Office Person
- Powerful Day
- Golfer Mode
- Senior Mode
- Dynamic Sports
- Healing

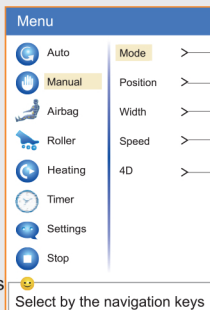

- Kneading
- Tapping
- Whole
- Shoulder
- Knocking
- Back
- Knead&Tap
- Waist
- Shiatsu
- Point
- Seat
- Level 1
- Level 2
- Level 3
- Level 4
- Level 5
- 4DLevel 1
- 4DLevel 2
- 4DLevel 3
- 4DLevel 4
- 4DLevel 5

Manual Mode: Press Menu, select manual message by navigation key, there are five options: Mode, Position, Width, Speed, 4D; choose the corresponding function, then press “OK” button to enter next menu. Massage method includes Kneading, Tapping, Knocking, Knead&Tap, and Shiatsu. Massage position: full body, shoulders, back, waist, seat, fixed point ; message width and speed; 4D hand feeling.

OPERATION GUIDE

Menu

- Auto
- Manual
- Airbag**
- Roller
- Heating
- Timer
- Settings
- Stop

Position > Full Body
Intensity > Level 1 - Shoulder
Level 2 - Hand
Level 3 - Seat
Level 4 - Leg
Level 5 - Feet

Select by the navigation keys

Airbag Massage: After pressing Menu button, choose Airbag through navigation key, press "OK" button. there are two kinds of air pressure related function: position and intensity; choose the corresponding function, then press "OK" to enter next menu and choose massage position between full body , shoulder , hand and seat, leg and feet. Massage strength has 5 levels.

Foot Roller: Press "Menu" button, select Roller by the navigation key. Press "OK" button to choose "Quick" "Soft" or "Stop".

Menu

- Auto
- Manual
- Airbag
- Roller**
- Heating
- Timer
- Settings
- Stop

Quick
Soft
Stop

Select by the navigation keys

Menu

- Auto
- Manual
- Airbag
- Roller
- Heating**
- Timer
- Settings
- Stop

Back ON
Foot ON
TEMP 1
TEMP 2
TEMP 3
TEMP 4
TEMP 5 (Hot)

Select by the navigation keys

Heating: Press Menu, choose Heating by navigation key, press "OK" button to choose the heating function such as Back on, Foot on, TEMP 1 to TEMP 5(Hot).

Timer : press "menu" key, through the navigation key to select menu item timing , can choose massage time : 10 minute to 60 minutes, the default time is 20 minutes, the chair will turn off automatically after time is up.

Menu

- Auto
- Manual
- Airbag
- Roller
- Heating
- Timer**
- Settings
- Stop

10 min
20 min
30 min
40 min
50 min
60 min

Select by the navigation keys

Menu

- Auto
- Manual
- Airbag
- Roller
- Heating
- Timer
- Settings**
- Stop

Language > Korean
English

Select by the navigation keys

Settings: After pressing "Menu" key, select settings through the navigation key and choose the language.

Stop: press "menu" key, select stop through the navigation key, it will stop massage, and get back to main interface.

When power on, the first time you use the auto program, massage chair will start the body scan and " body scanning ..." will be shown on screen. After the body scan is finished, the buzzer will tick 5 times(once every

second). At this point, the massage rollers are in the shoulder position, you can press Up and Down to adjust. When adjusting, "shoulder height adjusting..." will be displayed on the screen. The default working time is 20 minutes. The massage chair will turn off and reset to its upright position once the massage is over.

Auto-Recover

Speed : [Bar Chart] 20 min
Width : [Bar Chart]
Intensity : [Bar Chart]
4D : [Bar Chart]

Set function by pressing Menu key.

Annular functional area

● Legrest Up

Press this button on controller, legrest goes up. Release the button, legrest stops moving, the angle is locked in this position.

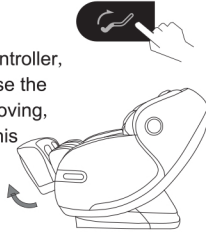

● Legrest Down

Press this button on controller, legrest goes down. Release the button, legrest stops moving, the angle is locked in this position.



● Legrest up and backrest down

Press this button on controller, backrest goes down and legrest goes up. Release this button, backrest and legrest stops moving, the angle is locked in this position.

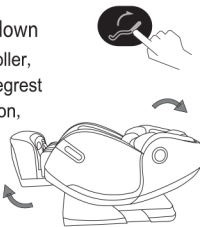

● Backrest up and Legrest down

Press this button on controller, backrest goes up and legrest goes down. Release this button, backrest and legrest stops moving, the angle is locked in this position.

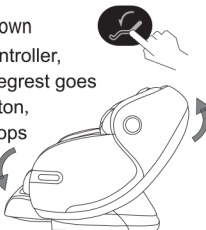

● Zero gravity

Press the "Zero Gravity" button on the remote control, the backrest will fall, the legrest will rise, and adjust the angle to achieve a comfortable zero gravity. It can effectively relieve the pressure on the spine and joints. Press this button again, the backrest will rise, the legrest will fall, and the angle will return to the power-on state.

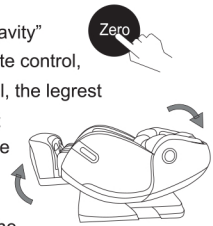

★ Tips: Zero-gravity

is according to the NASA Space capsule relax theory, through the back ,seat, legrest three sections multi angle changeable,

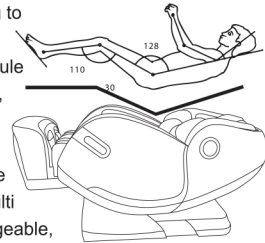

making the legrest up and seat down can make the angle 128 (+/-7)degrees between Body and legrest..let the heart and knee at the same level, reducing the blood circulation pressure to the lowest,but all the body pressure will put on the buttocks,And because of the ZERO GRAVITY position design,increase the forced area from the body and massage chair,so all the forces can be dispersed to the massage chair, reducing heart and spine pressure ,realizing the best Zero gravity massage experience. creating a completely relax,matural and comfortable massage posture.

CAUTION

1. Please make sure there is no people,no pets or any stuff around the backrest to avoid unexpected hurt or property loss.
2. When adjusting the backrest, be careful of the gap between the backrest and armrest.
3. When the legrest is moving, please do not stand on or leave from the seat,donot stop the legrest from moving in case of causing damage to the chair.
4. Please refer to control instruction for more details.

OPERATION GUIDE

- **Legrest extend and retract**
Legrest can extend and retract within 8.65inches automatically.

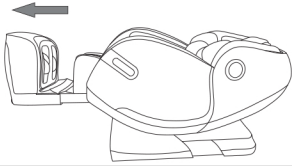

- **Arm massage**
Massage chair use space capsule type armrest, with built-in pulse air pressure massage function. Put the arms between armrest's air bags. After filling air, achieve kneading massage on the arms and hands. The arms could get comfortable massage in any angle of the chair.

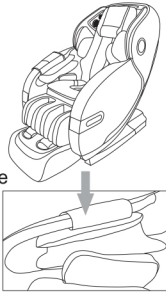

- **Shoulder massage**
Multi-layer exposed airbags are located on both shoulders to assist with stretch function. The 4D massage rollers push forward your body, while the airbags grip your shoulders to provide the ultimate full body stretch.

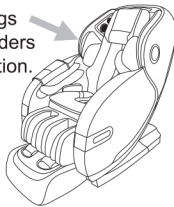

- **Warm foot therapy**
Innovatively developed two-way rotary foot kneading technique, realizing the sole function of kneading foot, combining with foot heating, it can perform best foot massage experience, good for health.

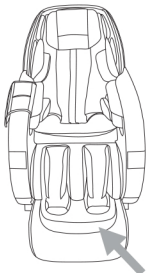

- **New Curve rail, Combination of back and buttocks massage.**
Massage chair adopts 4D curved rail technology, combining with 4D massage mechanism patent, realizing multi-angle integrated massage for back and buttocks. It has broken through traditional L shape rail's function which can't realize lying flat and stretching, and achieve best massage effect.

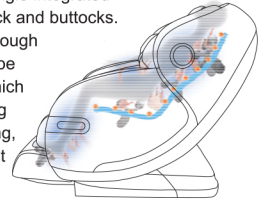

- **Music therapy**
There are multiple speakers surrounding the headrest. The blue-tooth wireless music player can integrates music into the massage techniques with synchronic therapy, which allow the rollers to massage you to the beats of your music. Relaxing to your own tunes will improve your blood and ease fatigue.

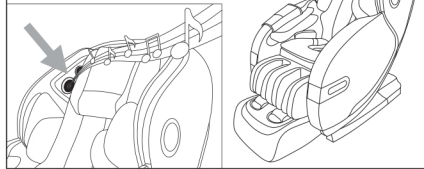

Attention!

- After using, press ON/OFF to end all the massage method and wait for restoration. Make sure to cut the electricity to avoid any unexpected hurt to children or pets.
- After using, turn off the power, unplug the electricity. Avoid moisture, dirt and aging of insulation in case of causing damage.

4.Voice control operation

*When the massage chair is open or in stand by made, say “Activate Kahuna” or press the voice control wake-up button on the right armrest to wake up the voice control function.

*After the successful wake-up, the massage chair will reply “Ready to massage”. At this time, the voice control entry corresponding to the function is realized within 6 seconds. After the massage chair is respond, the corresponding voice control function can be realized;if did not correctly say any voice entry for more than 6 seconds, the voice control function automatically turns off and needs to be reawakened.

Voice control enter		
Awakening words-“Active Kahuna” Answer – Ready to massage		
Serial No	Voice control entry	Answer entry
1	Active Kahuna	Ready to massage
2	Power OFF	Powering OFF
3	Change Position	Changing Position
4	Renew Massage	Start Renew Massage
5	Senior Massage	Start Senior Massage
6	Stretching Massage	Start Yoga Stretching
7	Heating ON	Heating ON
8	Heating OFF	Heating OFF

OPERATION GUIDE

| 3 After use |

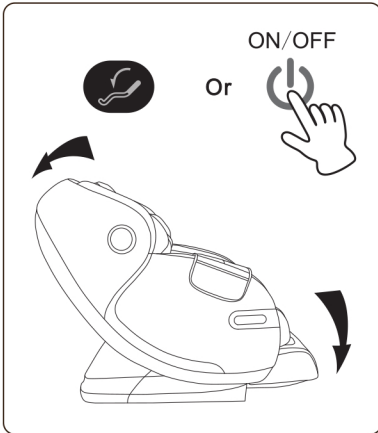

1. After the massage program is completed return the massage chair to upright position by turning off the massage chair.

Please check the surrounding prior to adjust the recline angle, paying special attention to children or pets that may be in close proximity.

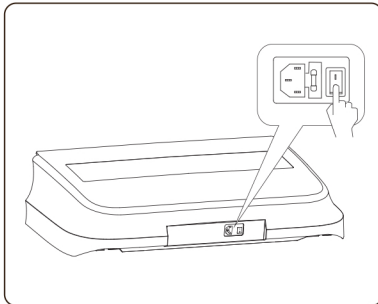

2. Press the power button to power off the massage chair and return remote controller to the storage area on arm pocket.

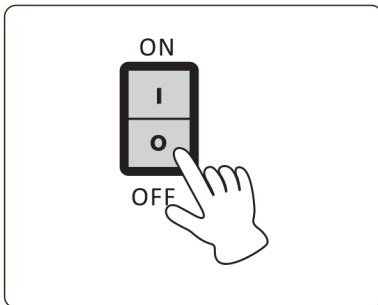

3. Turn off main power switch when you are not using the chair for a long period of time. Remove Plug from the power outlet to avoid accidents by kids and pets.

4. Do not operate with wet hands.

| Use dry cloth to clean |

Turn off and pull out the plug before cleaning the massage chair, do not touch the plug with wet hands.

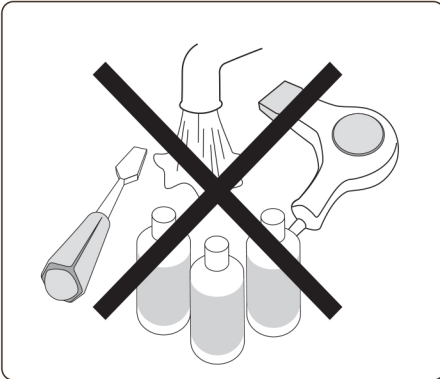
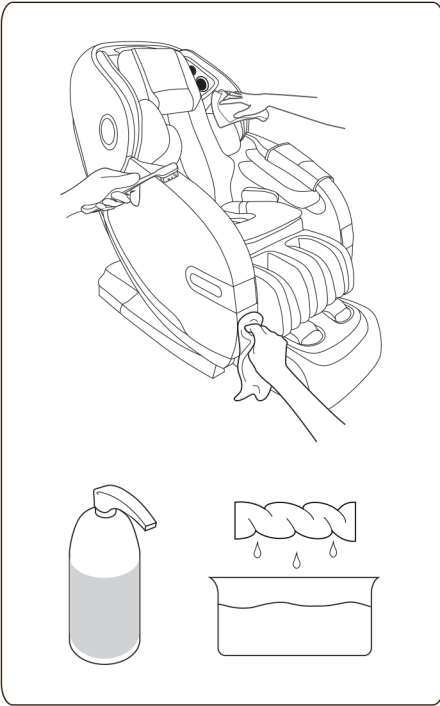

Prohibit using liquid cleaning products like water, alcohol, or other cleaning product to maintain a good quality.

TROUBLE SHOOTING

If the sounds or movements are not normal, please turn off the massage chair and remove the plug from the electric outlet. Please contact the customer service department for further assistance.

855.646.9500 / 1.714.388.2625, service@kahunachair.com

Problem	Solution
The massage chair is connected to power but is not functioning.	Check to see if the power plug is inserted or if the power outlet is functioning properly.
The remote controller is responding, but the massage chair is not functioning.	The massage chair may have automatically shut down due to overheating protection devices. Please turn off the power and allow the chair to cool off for 30 to 50 minutes.
Both the remote controller and massage chair are not responding.	The massage chair automatically turns into "full stop" mode when a massage program is completed. Please press the power button again to turn of the chair.



KAHUNA CHAIR PRODUCT WARRANTY REGISTRATION
<https://www.kahunachair.com/services/>

PRODUCT SPECIFICATIONS

Description	Specifications
Product Name	Kahuna Massage Chair
Model No.	SM 9300
Rated Voltage	120-240V~
Rated Frequency	50/60Hz
Rated Power Consumption	260 W
Product Dimension (LxWxH)	60 x 32 x 50 inches
Weight (LBS)	Net Weight: 338.5lbs Gross Weight :402.9lbs



Product KAHUNA Massage Chair

Model SM 9300

Distributed by AJX Distribution INC

11125 Knott Ave, Suite D

Cypress, CA 90630

Tel 1-855-646-9500

Email INFO@KAHUNACHAIR.COM

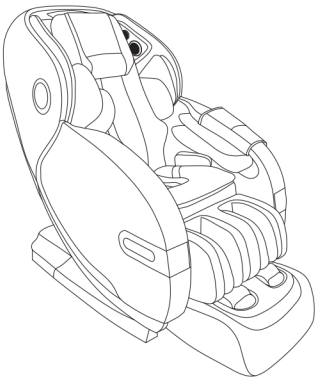

You must register warranty at www.kahunachair.com/services/

INSTRUCTION MANUAL
MODEL : SM 9300

Please read this user manual thoroughly
prior to operating the massage chair.
Store this booklet for future reference.