



## Atlas LE

### INSTRUCTION MANUAL

#### IMPORTANT SAFETY INSTRUCTIONS

Read all instructions before using (this appliance).

**DANGER** – To reduce the risk of electric shock:

1) Always unplug this appliance from the electrical outlet immediately after using and before cleaning.

**WARNING** – To reduce the risk of burns, fire, electric shock, or injury to persons:

1) An appliance should never be left unattended when plugged in. Unplug from outlet when not in use, and before putting on or taking off parts.

2) Do not operate under blanket or pillow. Excessive heating can occur and cause fire, electric shock, or injury to persons.

3) Close supervision is necessary when this appliance is used by, on, or near children, invalids, or disabled persons.

4) Use this appliance only for its intended use as described in this manual. Do not use attachments not recommended by the manufacturer.

5) Never operate this appliance if it has a damaged cord or plug, if it is not working properly, if it has been dropped or damaged, or dropped into water. Return the appliance to a service center for examination and repair.

6) Do not carry this appliance by supply cord or use cord as a handle.

7) Keep the cord away from heated surfaces.

8) Never operate the appliance with the air openings blocked. Keep the air openings free of lint, hair, and the like.

9) Never drop or insert any object into any opening.

10) Do not use outdoors.

11) Do not operate where aerosol (spray) products are being used or where oxygen is being administered.

12) To disconnect, turn all controls to the off position, then remove plug from outlet.

13) Do not use massager in close proximity to loose clothing or jewelry.

14) Keep long hair away from massager while in use.

15) Use heated surfaces carefully. May cause serious burns. Do not use over insensitive skin areas or in the presence of poor circulation. The unattended use of heat by children or incapacitated persons may be dangerous.

#### SAVE THESE INSTRUCTIONS

For use household only

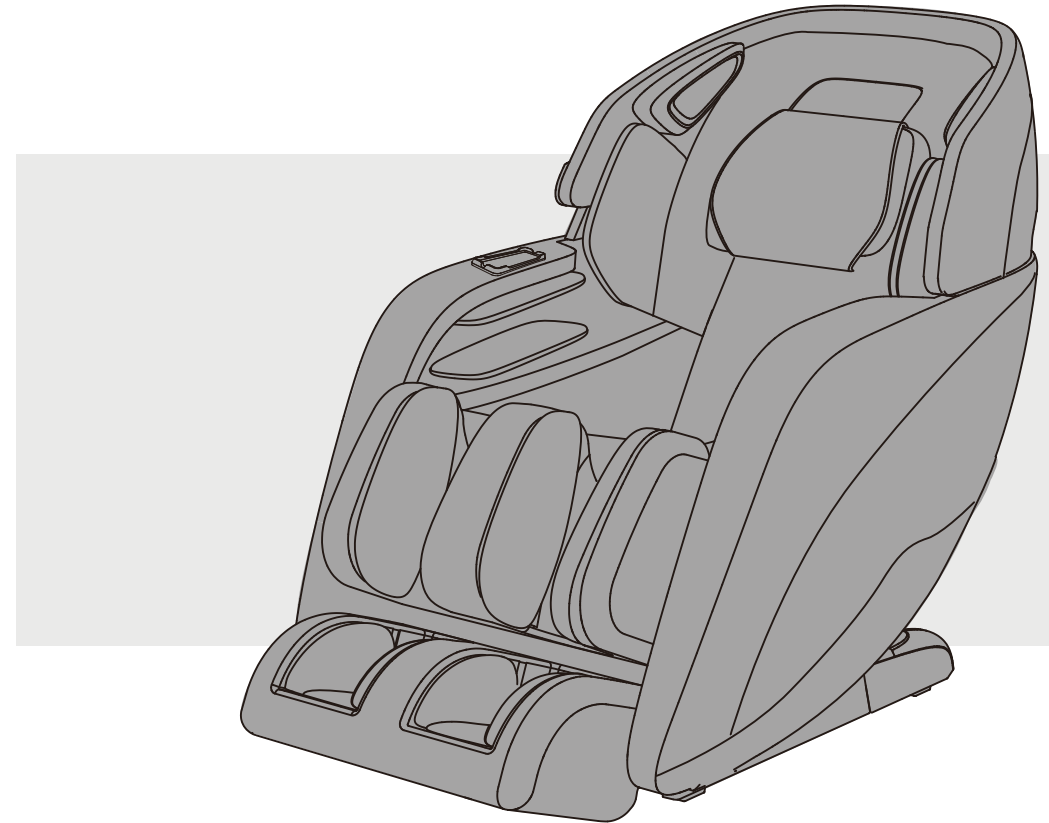

Please read all instructions carefully before using.

Thank you for purchasing this product. Please read this user manual carefully before using to ensure proper installation and operation.  
Please keep this USER MANUAL properly for future reference.

## ▶ PRODUCT SPECIFICATIONS

---

Product Name : Titan Massage Chair  
Model Number : Atlas LE  
Rated Voltage : 110-120V~  
Rated Frequency : 60Hz  
Rated current: 1.6A

## ▶ CONTENTS

---

SAFETY PRECAUTIONS .....	1
NAME AND FUNCTION OF EACH COMPONENTS .....	3
External Structure .....	3
Internal Structure .....	3
Remote Control .....	4
Remote Control Instructions .....	5
Display Screen Menu Instructions .....	6
FEATURES .....	13
INSTRUCTIONS OF OFF-LINE VOICE CONTROL .....	14
PRELIMINARY CHECKS .....	15
Installation Methods .....	15
Moving Methods .....	17
Connect to Power .....	17
Installation Site .....	18
Commissioning .....	19
Floor Protection .....	20
Best Circumstances .....	20
Grounding Instructions .....	20
Leg Extends/Retracts .....	21
Inspections Before Sitting .....	22
Audio Function .....	22
After Use .....	22
CARE AND MAINTENANCE .....	23
TROUBLE SHOOTING .....	24
PRODUCT SPECIFICATIONS .....	25

## ▶ TROUBLE SHOOTING





No.	Symptoms	Possible Causes	Possible Solutions
1	Noise is heard while in use.	These noises are normal and arise from friction between the massage rollers and the leather cover.	No need to take any measures.
2	Massage Chair does not start.	The power cord is not secured into the socket.	Insert the power plug properly into the power socket.
		Power switch is off.	Turn on the switch.
		The fuse is blown.	Replace only with a fuse of same type and rating.
3	No music comes from the speaker.	The volume is turned to the lowest.	Adjust the speaker volume from the mobile devices.
4	Backrest or footrest can not raise or recline.	Excessive load has been pressed on the backrest or legrest.	Reduce the load and try again.
5	Airbag malfunction.	The air hose is blocked.	Straight the air hose and clear out the blockage.

If problem remains, please contact the dealer for maintenance.

Tips: Do not attempt to repair this product yourself, our company shall not be liable for the injury or damage caused by any servicing without authorization. Thank you for your cooperation.

## ▶ SAFETY PRECAUTIONS

- ▶ Precautions listed below will help to ensure proper use of this appliance.
- ▶ The hazard that may cause by incorrect use are classified into “WARNING” and “CAUTION”, please ensure that you read all instructions before using the massage chair.

 <b>WARNING</b>	Improper operation may cause severe personal injury or substantial property damage.
 <b>CAUTION</b>	Improper operation may cause personal injury or product damage.
 Prohibited	 Do not Disassemble

### Not Suitable For Below Persons

We recommend that those with any of the following conditions should consult your physician before using.

 <b>WARNING</b>	<ul style="list-style-type: none"> <li>◆ Those who are using electronic medical instrument embedded in the body, such as cardiac pacemaker.</li> <li>◆ Those undergoing treatment, especially those who are not feeling well.</li> <li>◆ Those with malignant tumors or malignant abscesses. (Need to be supervised)</li> <li>◆ Those with osteoporosis or fracture spine.</li> <li>◆ Those with skin disease or those whose skins are injured.</li> <li>◆ Those with high fever.</li> <li>◆ Close supervision is necessary when this product is used by, on, or near children, invalids, or disabled persons</li> <li>◆ The appliance has a heated surface. Persons insensitive to heat must be careful when using the appliance.</li> <li>◆ This appliance can be used by children aged from 8 years and above and persons with reduced physical, sensory or mental capabilities or lack of experience and knowledge if they have been given supervision or instruction concerning use of the appliance in a safe way and understand the hazards involved.</li> <li>◆ Children shall not play with the appliance.</li> <li>◆ Cleaning and user maintenance shall not be made by children without supervision.</li> </ul>
--	--

### Control Buttons Precautions

 <b>CAUTION</b>	<ul style="list-style-type: none"> <li>◆ Do not operate the control buttons with wet hands.</li> <li>◆ Do not spill water or other liquid onto the control buttons to avoid fault.</li> </ul>
--	---

### Cautions Regarding the Adapters and Cord



 <b>CAUTION</b>	<ul style="list-style-type: none"> <li>◆ Always unplug this appliance from the electrical outlet immediately after using and before cleaning.</li> <li>◆ An appliance should never be left unattended when plugged in. Unplug from outlet when not in use.</li> <li>◆ Unplug from outlet during thunder or lightning storms, and before putting on or taking off parts.</li> <li>◆ Never operate this appliance if it has a damaged cord or plug, if it is not working properly, if it has been dropped or damaged, or dropped into water. Return the appliance to a service center for examination and repair.</li> <li>◆ Check that the power voltage stated on the rating label corresponds to your local electricity supply.</li> <li>◆ Do not use a damp hand to unplug the cord to avoid electric shock.</li> <li>◆ Do not drag the cord, reach to the front plastic end to unplug it.</li> <li>◆ Do not squeeze, over bend, pull hard, twist the cord.</li> <li>◆ Keep the cord away from heated surfaces.</li> <li>◆ Do not carry this appliance by supply cord or use cord as a handle.</li> <li>◆ To disconnect, turn all controls to the off position, then remove plug from outlet.</li> <li>◆ The appliance is only to be used with the power supply unit provided with the appliance.</li> <li>◆ It must only be supplied at safety extra low voltage corresponding to the marking on the appliance.</li> <li>◆ If the supply cord is damaged, it must be replaced by the manufacturer or its service agent or a similarly qualified person in order to avoid a hazard.</li> </ul>
--	--

## SAFETY PRECAUTIONS

### Best Circumstances

 <b>CAUTION</b>	<ul style="list-style-type: none"> <li>◆ Do not operate under blanket or pillow. Excessive heating can occur and cause fire, electric shock, or injury to persons.</li> <li>◆ Do not use this appliance where temperature is over 40°C.</li> <li>◆ Do not use this appliance in humid or dusty environment, or when any part of the body is in contact with plumbing or any similar ground.</li> <li>◆ Never operate the appliance with the air openings blocked. Keep the air openings free of lint, hair, and the like.</li> <li>◆ Do not use outdoors.</li> <li>◆ Do not operate where aerosol (spray) products are being used or where oxygen is being administered.</li> <li>◆ Please place the product on the flat level floor.</li> <li>◆ Do not store near heat or open flame.</li> <li>◆ Connect this unit to a properly grounded outlet only. See Grounding Instructions.</li> </ul>
---	--

### Best Practices For Safe Use

 <b>CAUTION</b>	<ul style="list-style-type: none"> <li>◆ Only for users weighs below 120kg.</li> <li>◆ Use this product only for its intended use as described in this manual. Do not use attachments not recommended by the manufacturer.</li> <li>◆ Do not use the product for therapeutic treatment purpose.</li> <li>◆ Appliance should only be used by one person, do not use by two or more persons at the same time to avoid damage to the products.</li> <li>◆ Do not use the product right after meal, it may cause discomfort.</li> <li>◆ Remove the accessories from the arms and empty the pockets while use the massage services.</li> <li>◆ Check the upholstery under the cushions and other spots, if any damages are present, do not use it and refer to a qualified service professional for servicing.</li> <li>◆ If you feel any abnormal discomfort during the operation of this product, turn off the power immediately and do not use the product.</li> <li>◆ Use the appliance for 20 minutes each time is highly recommended</li> <li>◆ Make sure there is no obstacles behind the chair and there is enough clearance before adjusting the backrest or legrest angle.</li> <li>◆ Make sure no other excessive load pressed on the backrest or legrest besides the user.</li> <li>◆ Make sure there is no children, pets or other objects under the backrest or legrest.</li> <li>◆ Please be seated properly while using the appliance.</li> <li>◆ Do not drag or push the chair or roll on its caster on wood floor or carpet to avoid damage.</li> </ul>
 <b>PROHIBITED</b>	<ul style="list-style-type: none"> <li>◆ Do not stand on or stack heavy objects on the footrest.</li> <li>◆ Do not fall into sleep while the product is operating.</li> <li>◆ Avoid using the product under the influence of alcohol.</li> <li>◆ Never drop or insert any object into any openings.</li> <li>◆ If there is any smoke or unusual smell while using, stop using immediately, unplug the power cord.</li> </ul>
 <b>NO DISASSEMBLY</b>	<ul style="list-style-type: none"> <li>◆ Do not disassemble this product yourself to avoid failure.</li> <li>◆ Do not dismantle, fix or modify the yourself, Please contact authorized dealer or service agent.</li> </ul>

## CARE AND MAINTENANCE

### Care and Maintenance Instructions

- ▶ To treat stains on back panel, armrest, footrest, plastic parts or air hose, spot clean with mild detergent foam, then wipe it with a dry cleaning cloth.
- ▶ To treat stains on controller, power box, spot clean with a dry cleaning cloth.
- ▶ To treat stains on back cushion or pillows, use a water-based upholstery cleaner only, wipe it with moist cloth, then air dry.
- ▶ To clean the foot/calf unit covers, remove it from the chair, hand wash with a mild detergent, then line dry.

#### **CAUTION**

- ▶ Pull out the power cord from the power strips before care and maintenance. To avoid electrical shock or injury, do not touch the power cord with wet hands. Make sure no detergent enter into the power box while cleaning.
- ▶ Do not use benzene, thinner or other solvents on your product, it may cause fading or damage to the product.
- ▶ Do not iron the upholstery.

### Storage Methods

- ▶ Keep the product free from dust. Cover the product with a dust-free cloth to prevent collection of dust if not in use of a long period of time.

#### **CAUTION**

- ▶ Do not leave this product exposed to direct sunlight for long periods of time. This may cause fading or damage.

### Warm Tips

During daily use, please check for the following symptoms:

- ▶ Burnt smell.
- ▶ The product experiences unusual power ON/OFF when touching the power cord.
- ▶ Hot power cord.
- ▶ Other abnormal symptoms.

#### **CAUTION**

- ▶ Please stop using the product to avoid breakdowns or accidents if any above symptom spotted.
- ▶ Switch off the power button and disconnect the plug, contact the local distributors or supplier for repair.
- ▶ All other servicing except above care and maintenance should be serviced by an authorized dealer or service center.

#### **WARNING**

Pull out the power cord from the power strips before care and maintenance. To avoid electrical shock or injury, do not handle the power cord with wet hands. Do not try to dismantle or repair the product yourself, please send your massage chair to the authorized service center.

## ▶ PRELIMINARY CHECKS

### Inspections Before Sitting

- ▶ Ensure the footrest is well assembled before sitting on the massage chair.
- ▶ Ensure the massage chair is returned to its original position before sitting on it. If there is any part not in default position, please turn off the massage chair to allow it to restore.

#### CAUTION

- ▶ Do not take seat while the footrest is lifted.
- ▶ Do not put excessive load on the footrest to avoid damage.

### Audio Function

- ▶ To play sound, turn on bluetooth on your Android/Apple iOS device and place the massage chair in discovery mode to pair.

### After Use

- ▶ Put the Remote Control into the Remote Control Pocket.
- ▶ Turn off the power switch and unplug the massage chair from the electrical outlet while not in use to avoid children power on the massage chair accidentally.
- ▶ When not in use for a long period of time, we recommend that the chair be covered, the power cord be coiled and that the unit be placed in an environment free of dust and moisture.

## ▶ NAME AND FUNCTION OF EACH COMPONENT

### External Structure

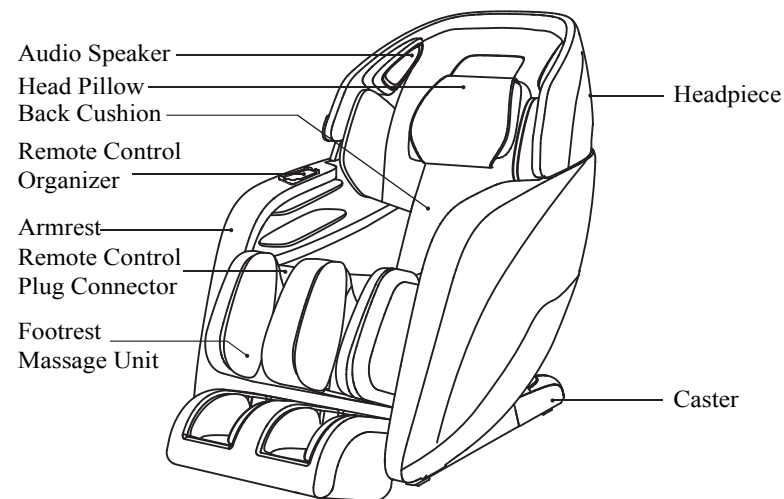

### Internal Structure

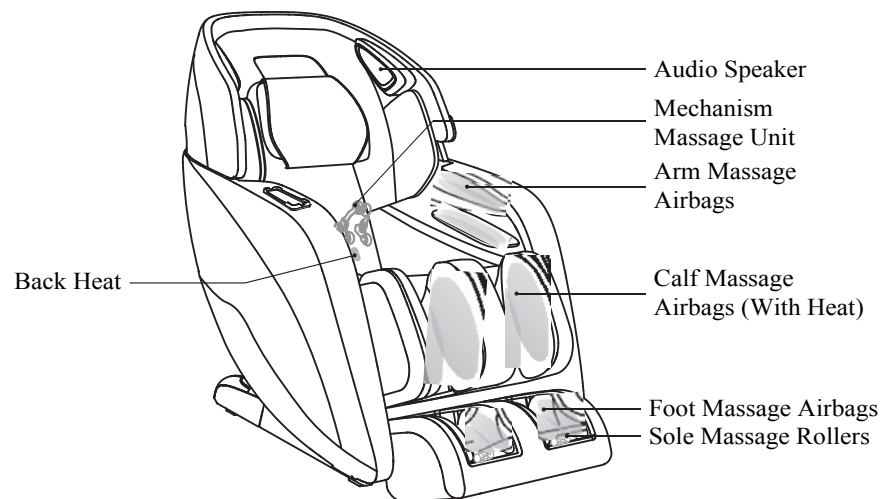

## ▶ NAME AND FUNCTION OF EACH COMPONENT

### Remote Control

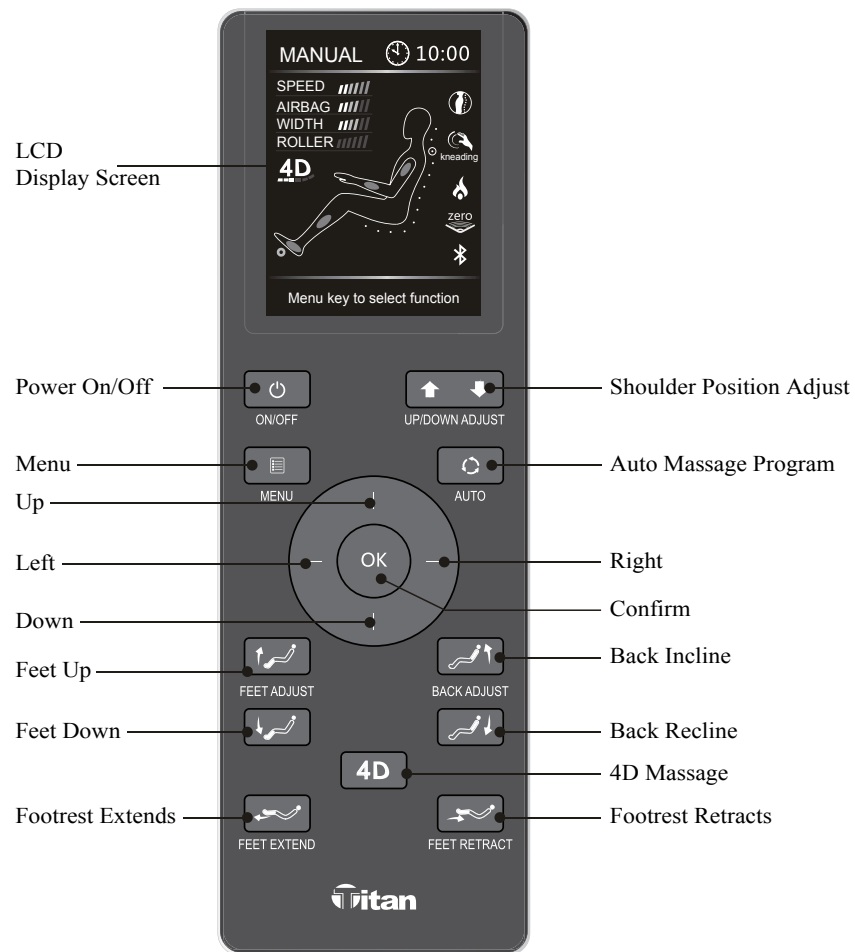

## ▶ PRELIMINARY CHECKS

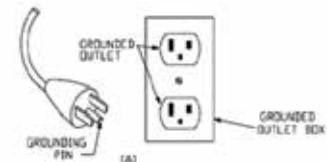

This product is for use on a nominal 120-V circuit and has a grounding plug that looks like the plug illustrated in sketch A in following figure. Make sure that the product is connected to an outlet having the same configuration as the plug. No adapter should be used with this product.



### Grounding

This massage chair belongs to LevelOne electrical appliance, make sure to use three-core power supply socket and to guarantee the ground wire connected to the power supply socket has obtained good ground connection to avoid electric leakage, electric shock and some other negative effect during use.

### Footrest Extends/Retracts

- ▶ Press and hold “” “” button on the Remote Control to extend or retract the footrest to the length you desire for better massage experience, release the button to fix the position.

Footrest Extended 

Footrest Retracted 

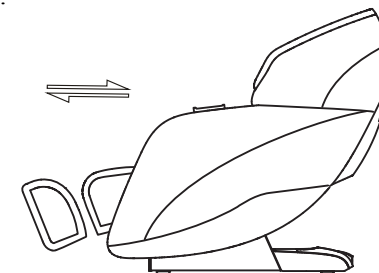

- ▶ A footrest sensor is set at the bottom of footrest, the footrest will adjust the length automatically once the chair started.

### WARNING

- ▶ Do not play on the massage chair or operate it improperly.
- ▶ Ensure there is no obstruction when raising or reclining the backrest and footrest.
- ▶ Do not place foot, fingers or any other objects in the space between the seat and the backrest/footrest when it is in the reclining or raising motion.
- ▶ Ensure massage chair is restored back to its original position before getting off the massage chair.

## ▶ PRELIMINARY CHECKS

### Floor Protection

- ▶ We recommend to place a piece of carpet or soft mat underneath it to avoid damaging the floor.

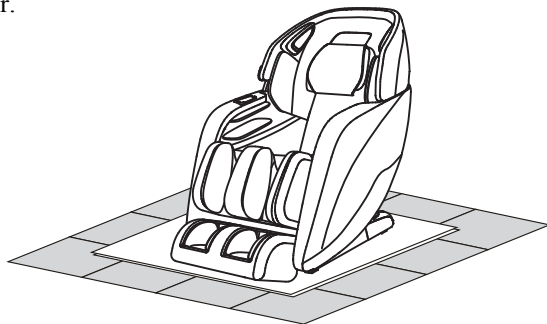

### Best Circumstances



Do not use the massage chair in high moisture environment such as near swimming pool or bathroom to prevent electric shock accident.



Please keep the massage chair away from heated surfaces to prevent fire hazard or damage to the product.

### WARNING

- ▶ Do not use the massage chair in high moisture environment such as near swimming pool or bathroom to prevent electric shock accident.
- ▶ Please keep the massage chair away from heated surfaces to prevent fire hazard or damage to the product.

### GROUNDING INSTRUCTIONS

This product must be grounded. If it should malfunction or breakdown, grounding provides a path of least resistance for electric current to reduce the risk of electric shock. This product is equipped with a cord having an equipment-grounding conductor and a grounding plug. The plug must be plugged into an appropriate outlet that is properly installed and grounded in accordance with all local codes and ordinances.

**DANGER** – Improper connection of the equipment-grounding conductor can result in a risk of electric shock. Check with a qualified electrician or serviceman if you are in doubt as to whether the product is properly grounded. Do not modify the plug provided with the product – if it will not fit the outlet, have a proper outlet installed by a qualified electrician.

## ▶ NAME AND FUNCTION OF EACH COMPONENTS

### Remote Control Instructions



**Power:** Press this button to power on/off the remote control.

- ▶ Press this button while connected to power to show the menu display, the LCD Screen lights up, use the UP/DOWN/LEFT/RIGHT buttons to navigate the screen, press OK to select.
- ▶ Press this button again to turn off the product.  
(The default massage timing is 20 minutes)



**Menu**

- ▶ Display the Auto Program, Manual Program, 3D Massage, Airbags, Heat and Setting. (Check the Display Menu for detailed information)



**Shoulder Position Adjust**

- ▶ Press and hold on Position UP/DOWN button to adjust the rollers to the desired position while under manual program or 3D Massage Point massage mode.
- ▶ Press and hold on Position UP/DOWN button to adjust the rollers to the desired position while under the body scan procedure.



**Auto Program**

- ▶ Display the auto mode menu. when an auto program is running, press this button to toggle among the auto programs. The active program displays at the top of the status screen.  
(Check the Display Menu for detailed information)



**Navigation**

- ▶ Use the UP/DOWN/LEFT/RIGHT buttons to navigate the screen, press OK to select.



**4D Massage**

- ▶ While manual massage program is running, press this button to change the 4D protruding intensity.



**Feet Up**

- ▶ Press and hold to raise the Legrest Unit, release the button to stop.



**Feet Down**

- ▶ Press and hold to lower the Legrest Unit, release the button to stop.

## ▶ NAME AND FUNCTION OF EACH COMPONENTS



### Back Incline

▶ Press and hold to raise the backrest,release the button to stop.



### Back Recline

▶ Press and hold to recline the backrest,release the button to stop.



### Footrest Extends

▶ Press and hold to extend the footrest,release the button to stop.



### Footrest Retracts

▶ Press and hold to retract the footrest,release the button to stop.



#### WARNING

After using,press Power button to restore the chair,press any button on the remote control to stop the restoration,press Power button again for further operation.

## Display Screen Menu Instructions

### ▶ Auto Program

Press to display the Auto Program menu,press this button to toggle among 9 Auto Programs: BOSS NURSING,GENTLE TREATMENT,BODY CARE,EXTENTION, NECK&SHOULDER,WAIST&SPINE,SPORTS REFRESH,WORKING RELIEF, REST&SLEEP.Press OK to enter the program you desire.Selected program will show on the home screen.

▶ **Boss Nursing:**Delivers an intense massage focusing on relieving sore and tension in the neck and shoulders,bringing utmost relief and comfort for users who spends long hours at desk.

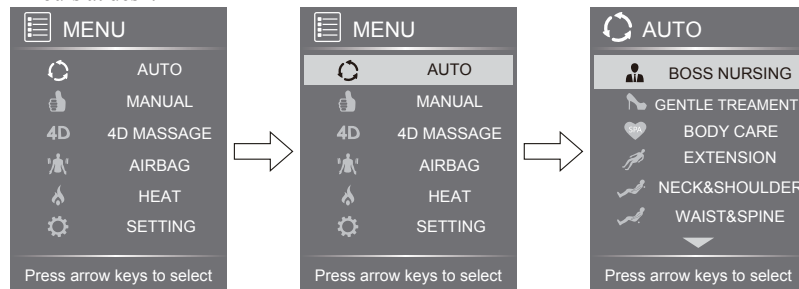

## ▶ PRELIMINARY CHECKS

### Commissioning

- ▶ Use the remote control to recline the backrest to its lowest position,raise and extend the footrest to its top position, make sure there is enough clearance before commissioning.
- ▶ Return the backrest and footrest back to its default position after commissioning and turn off the power switch.  
To choose the massage program, please check the Instructions of Remote Control and Instructions of Display Screen for reference.

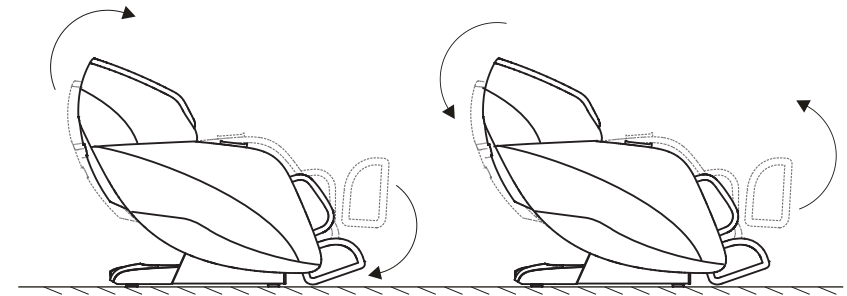

#### DANGER

- ▶ Improper connection of the equipment grounding conductor can result in a risk of electric shock. Check with a qualified electrician or serviceman if you are in doubt as to whether the product is properly grounded. Do not modify the plug provided with the product – if it will not fit the outlet, have a proper outlet installed by a qualified electrician.



#### EARTHING

- ▶ This massage chair belongs to Level One electrical appliance,make sure to use three-core power supply socket and to guarantee the ground wire connected to the power supply socket has obtained good ground connection to avoid electric leakage,electric shock and some other negative effect during use.



## ► PRELIMINARY CHECKS

### Installation Site

#### Clearance space for the massage chair:

- Ensure there is an adequate clearance for the installation:  
It needs 10cm clearance for the recline of the backrest;  
It needs 60cm clearance space for the extension of footrest and sliding forward of the chair.
- Keep it 1 meter away from the TV, radio or other audio&video appliance to avoid signal interference.

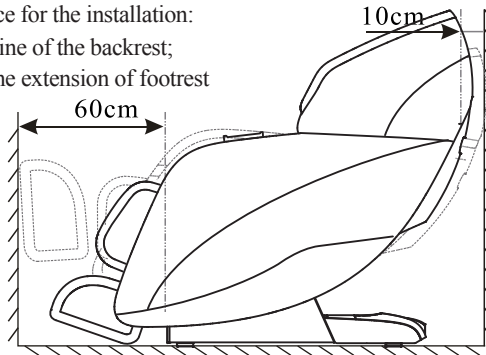

- Keep the distance between the power socket and power switch within 1.5 meter.

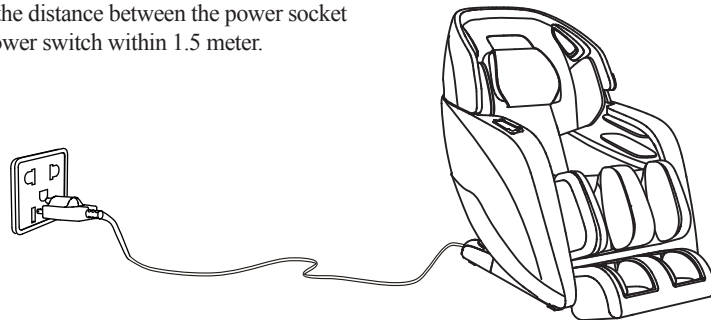

#### ⚠ CAUTION

- Keep the distance between the power socket and power switch within 1.5 meter to avoid damage of power cord while massage chair sliding forward.
- Straighten the power cord while in use to avoid tangle or damage.
- When the massage chair sliding forwards or back, please check to make sure there is no children, pets or other obstacles around to avoid accident.

#### ⚠ IMPORTANT

- This product is for use on a nominal 220-V circuit and has a grounding plug that looks like the plug illustrated in sketch A in following figure. Make sure that the product is connected to an outlet having the same configuration as the plug. No adapter should be used with this product.

## ► NAME AND FUNCTION OF EACH COMPONENTS

- **Gentle treatment:** Adopts mild massage techniques to relax muscles in the back and waist, helping to shape body figure and promote metabolism.
- **Body Care:** Designed for morning or midday relaxing, it helps to boost the viability of muscles.
- **Extension:** Inspired by Thai style massage, featured in extension and stretching, this program uses strong kneading and stretching technique to relax tired muscles and keep them flexible.
- **Neck&Shoulder:** Designed to help to ease the pain and stiffness in neck and shoulders, combined with curvature design of the backrest, this program targets the rollers at the deep tissue of neck and shoulders.
- **Waist&Spine:** Focusing the massage on the lumbar vertebra, this program helps to soothe the tension and keep the vitality of muscles
- **Sports Refresh:** Designed for muscles relaxation after sports activity and exercise, it helps to ease muscles tension, promote body circulation and facilitate sports recovery.
- **Working Relief:** Designed for the ordinary working persons, this program helps to rejuvenate both physically and emotionally.
- **Rest&Sleep:** Designed for improving nap and sleep quality, this program adopts gentle massage techniques to relieve body fatigue.

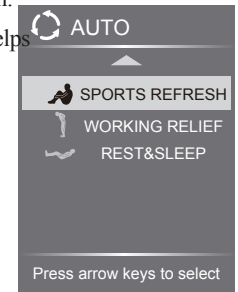

### ► Manual Program

Press MANUAL from MENU display, press UP or DOWN button to navigate among: MODE, PART, WIDTH, SPEED, ROLLER and ZERO.

- **Message Mode:** Press Mode from Manual display, press RIGHT button then press UP or DOWN button to navigate among: Kneading, Tapping, Knocking, Shiatsu, Sync, 4D Shiatsu, Percussion and Pressing massage techniques. Press OK button to enter the setting you desire. Selected mode will show on the home screen.

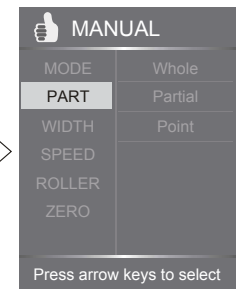
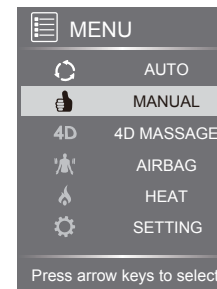

## NAME AND FUNCTION OF EACH COMPONENTS

- ▶ **Message Part:** While Manual massage program is running, press this button to navigate among: Whole, Partial and Point massage regions.
- ▶ **Back Mechanism Massage Width:** Press WIDTH from MANUAL display, press RIGHT button then press UP or DOWN button to navigate among: Wide, Medium and Narrow mechanism roller width. Press OK button to enter the setting you desire. Selected width will show on the home screen.

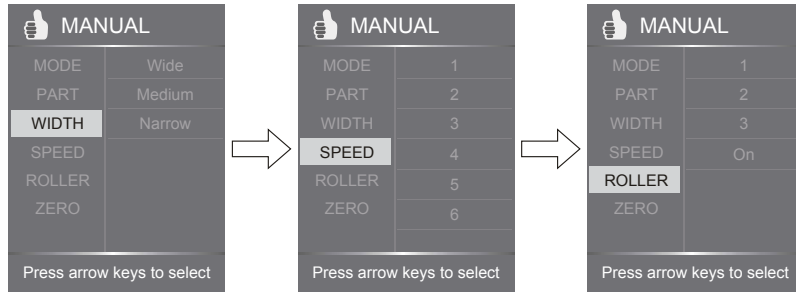

- ▶ **Back Mechanism Massage Speed:** Press SPEED from MANUAL display, press RIGHT button then press UP or DOWN button to navigate among: level 1,2,3,4,5,6 Mechanism massage speed. Press OK button to enter the speed level you desire.

- ▶ **Roller:** Press ROLLER from MANUAL display, press RIGHT button then press UP or DOWN button to navigate among: foot roller speed level 1,2,3, or Off (deactivate foot roller mechanism) . Press OK button to enter the speed level you desire.

- ▶ **Zero Gravity:** Press ZERO Gravity from Manual display, press RIGHT button then press UP or DOWN button to activate or deactivate Zero Gravity. Press OK button to enter the setting you desire.

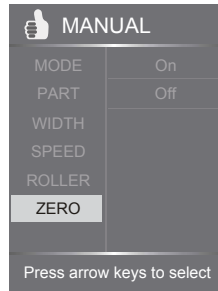

### ▶ 3D Massage Program

Press 3D MESSAGE from MENU display, press OK button to enter 3D Message display, then press UP or DOWN button to navigate among:  
 Press 3D Message from Menu display to enter 3D Message display, press RIGHT then press UP or DOWN button to navigate among MODE-3 pre-set 3D Massage programs (Deep Shiatsu, Healthy Breath and Massage Extend), FORCE-3D protruding intensity (1,2,3,4,5) and PART-3D massage part (Whole, Partial, Point). Press OK button to enter the setting you desire.

## PRELIMINARY CHECKS

### Move Method

- ▶ Roll the chair on its casters to the desired location.
- ▶ Incline the backrest to upright position.
- ▶ Turn off the power switch and unplug the appliance from the electrical outlet.
- ▶ Using two people, push down on the backrest and lift up on the front side by grabbing the moving Holder located to the front bottom of the armrest, roll the chair on its casters to the desired location (check the sketch for reference).

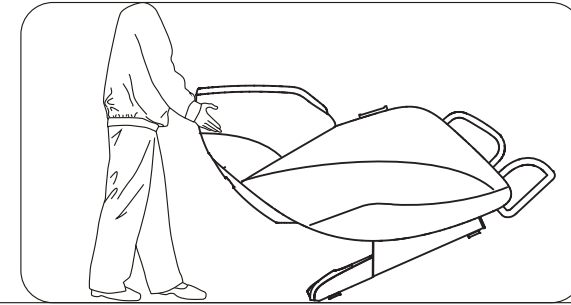

### ⚠ CAUTION

- ▶ Do not move the chair when there is user inside.
- ▶ To carry this product, do not lift by the footrest or armrest, hold the chassis and steady the backrest (have 4 or more people to carry the product).

### Connect to Power

- ▶ Connect this appliance to a 3-wire properly grounded outlet.
- ▶ Turn on the power switch located at the back of power box.

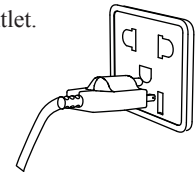

### ⚠ CAUTION

- ▶ Please verify that there is no damage to the supply cord before switching on the massage chair.
- ▶ Please verify that the main power switch is turned off before connecting to power.

## ▶ PRELIMINARY CHECKS

- ▶ Connect the power cable to the product power socket located at the power box of the product.(Check below illustration for reference)

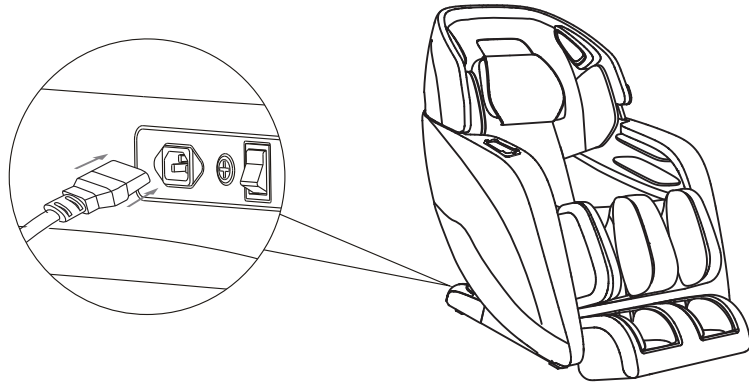

## ▶ NAME AND FUNCTION OF EACH COMPONENTS

- ▶ **4D Massage Mode:** While 4D massage program is running, press this button to navigate among: deep shiatsu, healthy breath and massage extend 4D massage programs.
- ▶ **Deep Shiatsu:** 10 minutes deep shiatsu massage mainly performs in-depth massage on the back.
- ▶ **Healthy Breath:** 5 minutes deep healthy breath massage allows user to inhale and exhale with the rhythm of mechanism motion to improve the user's state of wellness.
- ▶ **Massage Extend:** 5 minutes full extension massage.

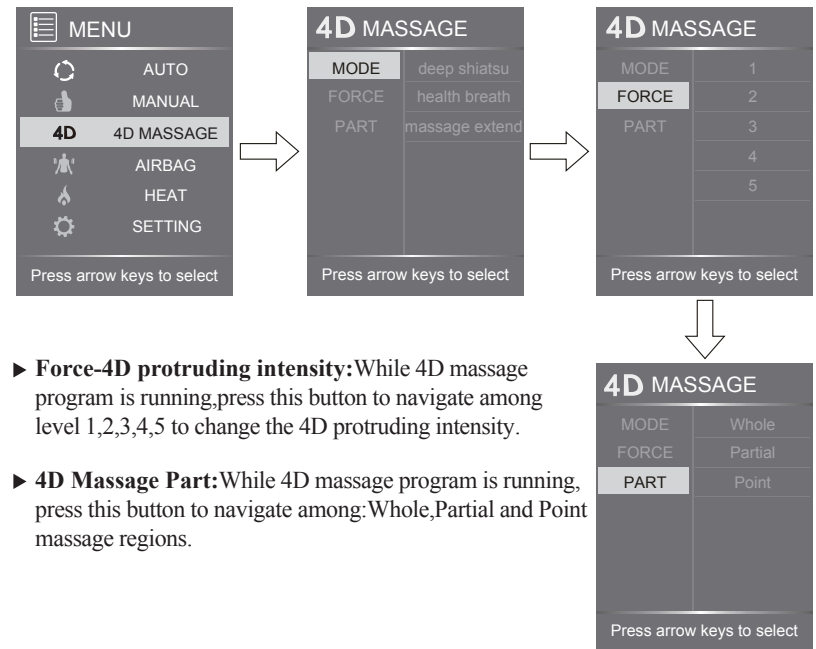

- ▶ **Force-4D protruding intensity:** While 4D massage program is running, press this button to navigate among level 1,2,3,4,5 to change the 4D protruding intensity.
- ▶ **4D Massage Part:** While 4D massage program is running, press this button to navigate among: Whole, Partial and Point massage regions.

### ▶ Air Pressure Massage

**Airbag:** Press Airbag from Menu display to show the Airbag display, press RIGHT button then press UP or DOWN button to navigate between: Part-Air pressure region and Force-Air pressure intensity, Press OK button to enter the setting you desire.

- ▶ **Part-Air pressure region:** Press PART from AIRBAG display, press RIGHT button then press UP or DOWN button to navigate among: Full, Arm&Shoulder, Back&Waist, Leg&Foot, Buttock airbag positions. Press OK button to enter the airbag position you desire.

## ▶ NAME AND FUNCTION OF EACH COMPONENTS

- ▶ **Force-Air pressure intensity:** Press Force from Airbag display, press RIGHT button then press UP or DOWN button to navigate among: level 1,2,3,4,5 airbag intensity, or Off (deactivate airbag intensity function), Press OK button to enter the airbag setting you desire.

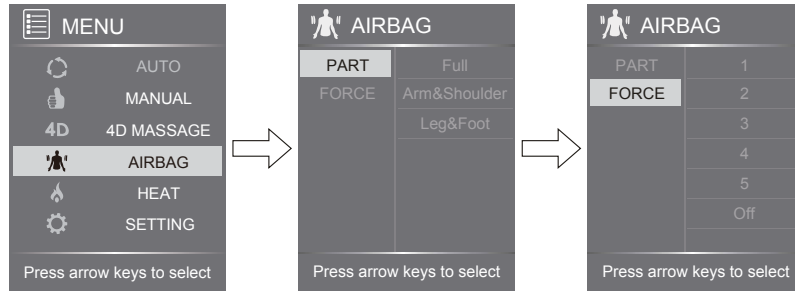

### ▶ Back&Leg Heat

Press HEAT from MENU display, press RIGHT then press UP or DOWN button to turn ON/OFF backrest and legrest heat, Press OK button to enter the heat setting you desire.

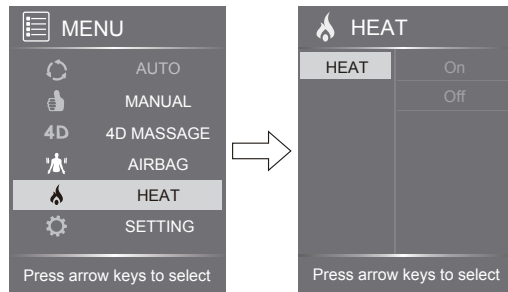

### ▶ Settings

Press SETTING from Menu display, press OK button to enter Settings display, then press UP or DOWN button to navigate among: TIME, LANGUAGE, BLUETOOTH, and VOICE.

- ▶ **Time:** Press Time from Settings to show available timer: 10mins, 20mins, 30mins. Press RIGHT button then press UP or DOWN button to navigate, press OK button to enter the timer you desire.

## ▶ PRELIMINARY CHECKS

### Installation Method

#### Step 1: Take all massage chair units out of the cartons

- ▶ Unpack the cartons: take out all upholstery unit, accessories out of the cartons.
- ▶ Before beginning installation, please verify that all components are included (check with the packing list carefully)

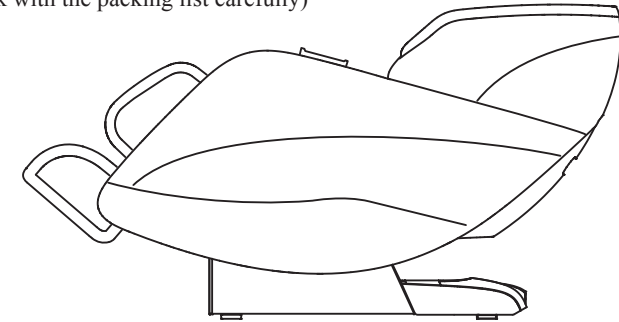

#### Step 2: Install the controller unit

- ▶ Take the controller unit out of the accessories box; Connect the data line of the controller to the port to the lower inner side of the right armrest (pay attention to the convex and concave of the connector and port), then tighten the screw cap clockwise. (Check the illustration below for reference)

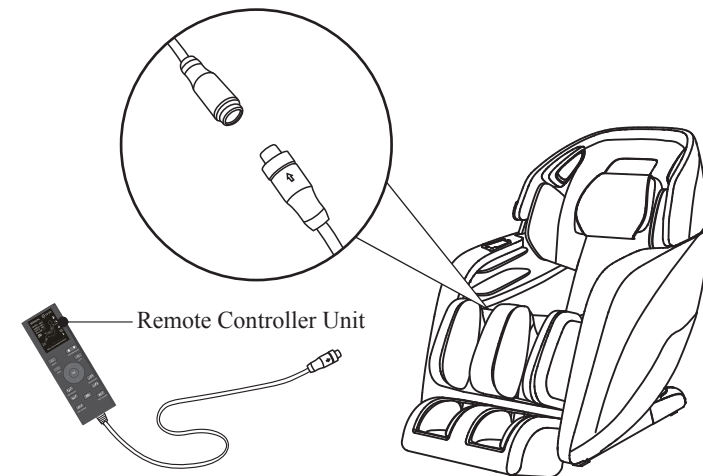

## ▶ FEATURES

### Instructions of Off-line Voice Control

▶ **Language Support: English and Mandarin Chinese**

▶ **Voice Command:**

Switch to Voice Mode  
 Power On  
 Switch Off  
 Boss Nursing  
 Gentle treatment  
 Body Care  
 Sports Refresh  
 Extension  
 Rest and Sleep  
 Working Relief  
 Neck and Shoulder  
 Waist and Spine  
 Air Bag Massage  
 Deep Shiatsu  
 Healthy Breath  
 Massage Extend  
 Zero Gravity  
 Start Heat  
 Heat Off

▶ **Press VOICE from Settings Display on remote control,switch VOICE to On.**

Voice device can be activated by touching the square shaped groove on the left speaker or saying“switch to voice mode”, “Please tell your command”will be heard when voice is activated.

## ▶ NAME AND FUNCTION OF EACH COMPONENTS

- ▶ **Language:**Press Language from Settings to show available language: 中文, EN. press RIGHT button then press UP or DOWN button to navigate,press OK button to enter the language you desire.
- ▶ **Bluetooth:**From BLUETOOTH,press RIGHT button then press UP or DOWN button to activate or deactivate Bluetooth function.press OK button to enter the setting you desire.
- ▶ **Voice:**From VOICE,press RIGHT button then press UP or DOWN button to activate or deactivate Voice control function.press OK button to enter the setting you desire.

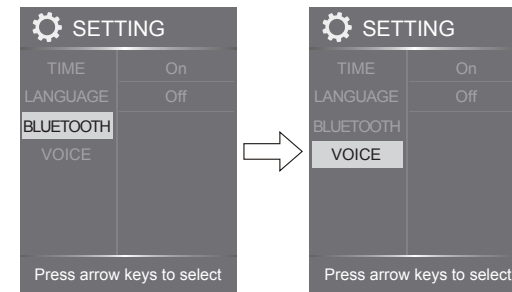
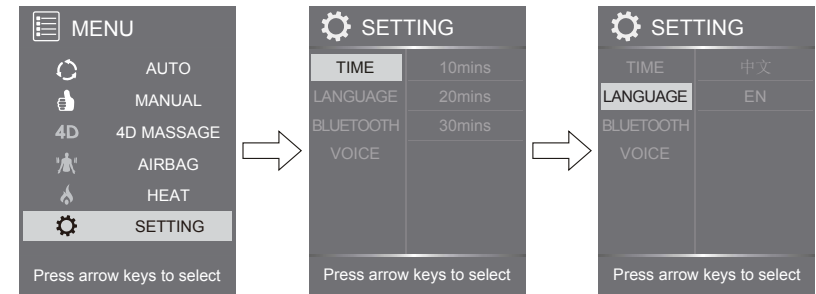

## ▶ NAME AND FUNCTION OF EACH COMPONENTS

### Tips:

In the process of Auto or Manual Setting,LCD screen will auto revert back to the homescreen after 10 seconds if there is no operation entered into the remote control. (Check the illustration below for reference)

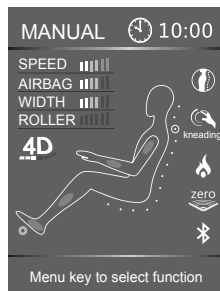

Homescreen display with the Manual program running

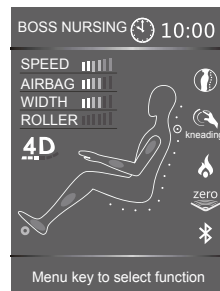

Homescreen display with the Auto program running

### 😊 Tips:

- ▶ While appliance is running,press twice MENU button to revert to homescreen.
- ▶ Under the homescreen display,press LEFT or RIGHT button to adjust the airbag intensity(works in the process of both Auto and Manual program);press UP or DOWN button to adjust the massage intensity. (only works in the process of Manual program)
- ▶ Press Auto button to select auto massage program.

### ⚠ CAUTION

- ▶ Do not disassemble this product yourself to avoid product failure.
- ▶ Make sure no water or other liquid enters into the remote control to avoid fault.
- ▶ Do not pinch or squeeze the remote control or power cord.

## ▶ FEATURES

### 1.Slide Forward While Reclining

While 3D massage program is running,press this button to navigate among:deep shiatsu,healthy breath and massage extend 3D massage programs.

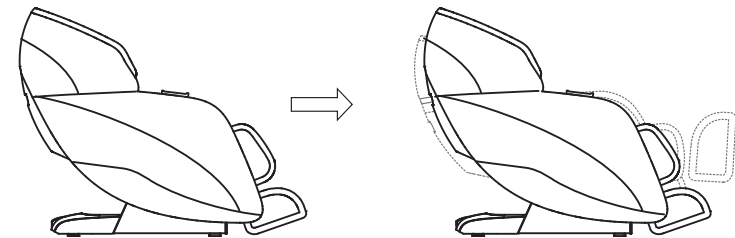

### 2.Human Hand Quad Style Massage Rollers

Innovative Human hand quad style massage rollers and L-shaped guiding track conform to ergonomic principle.

### 3.Auto Extension Legrest

Legrest can extend by maximum 26cm automatically,fulfilling the need of diversified statures.

### 4.Air Pressure Massage

Air pressure massage for arms,calves and feet.

### 5.Roller Massage

3 underfoot rollers provide all-direction pressure massage for the reflex zone.

### 6.Versatile Massage Techniques

Mimic human hand Kneading,Tapping,Knocking,Shiatsu,Sync,3D Shiatsu,Percussion and Pressing massage techniques for custom-tailored relaxation.

### 7.Candy Bar Style Remote Control

Simple and easy-to use remote control, android system serves simple and easy to understand access to all functions.

### 8.Intelligent Voice Control

Turn On/Off the massage chair or change massage programs by speaking to free your hands and rest head to toe.