

Osaki Massage Chair
www.osakimassagechair.com

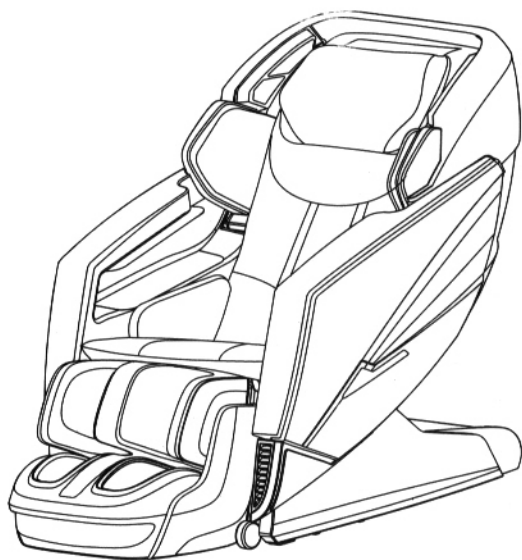

Executive 3D Multi-functional Massage Chair

OS:PRO-EKON
USER MANUAL

Thank you for your purchase of this product. Before using, please read this USER MANUAL carefully, and pay special attention to the safety precautions to ensure proper usage and safety.

Please keep this USER MANUAL for further reference.





CONTENTS

SAFETY PRECAUTIONS	1
NAME AND FUNCTION OF EACH COMPONENT	3
External structure	3
Internal structure	3
Controller	4
Instruction of Controller	5
Instruction of Display screen menu	6
PREPARATION BEFORE USING	12
Installation Method	12
Move method	16
Turn on power supply	16
Installation position	18
Floor protection	18
Surrounding environment	18
Grounding	19
Massage chair commissioning	19
Before sitting in the chair	20
Legrest Extend and Retract	20
After using	20
APP DOWNLOAD AND INSTALLATION	21
PRODUCT STORAGE AND MAINTENANCE	23
TROUBLE SHOOTING	24
TECHNICAL SPECIFICATIONS	25



▶ SAFETY PRECAUTIONS

Safety Precautions

- ▶ Before using, please read the “SAFETY PRECAUTIONS” carefully to ensure proper operation.
- ▶ The following “SAFETY PRECAUTIONS” is of great help in correctly using the massage chair.
- ▶ To clearly indicate the degrees of danger and damage, the classes of accidents caused by incorrect use are classified into “WARNING” and “CAUTION”, instructions marked as followings should be strictly followed:



	WARNING	Improper operation may cause injury to users.
	CAUTION	Improper operation may cause users injury or product damage.
		Forbidden. Specific instruction will be indicated in the diagram drawings.(E.g, the left drawings means disassembly is not allowed.)
		Compulsory Specific instruction will be indicated in the diagram drawings.(e.g, the left drawings means to disconnect the power plug)

WARNING

 COMPULSARY	<p>We recommend that those with any of the following conditions should consult a doctor before using.</p> <ol style="list-style-type: none"> 1. Those who are using electronic medical device implanted in the body, such as cardiac pacemaker. 2. Anyone with any medical condition MUST consult with a doctor prior to using a massage chair. 3. Anyone with tumors or cancer MUST consult with their doctor authorization to use the chair. 4. Women who are pregnant or menstruating. 5. Those with osteoporosis or fracture spine or any spinal disorder. 6. Those with skin disease or a skin condition. 7. Those whose body temperatures is not normal.
 PROHIBITED	<ul style="list-style-type: none"> ◆ If physically or mentally handicapped, they should have someone monitor and assist at all times. ◆ Do not allow children play on massage chair. ◆ Do not allow more than one person to use this massage chair at a time. ◆ If the power cord or power plug becomes damaged in any way you must disconnect from the power outlet immediately and consult an authorized service engineer for repair or replacement. ◆ Do not damage, excessively bend, pull hard, twist or knot power cord. Juveniles are not allowed to use this product. ◆
 NO DISASSEMBLY	<p>Only certified maintenance personnel specified by the manufacturer are allowed to disassemble, repair or remodel this massage chair. If any problem, please contact local dealer immediately.</p>

▶ SAFETY PRECAUTIONS

! CAUTION

 COMPULSARY	<ul style="list-style-type: none"> ◆ Please do not use the massage chair over 20 minutes per day, and it is limited to massaging a particular part of body of 5 minutes. ◆ Please put the massage chair on flat leveled ground for use. ◆ When adjusting the legrest or backrest, please do not exert excessive force on it; in addition, keep children and pets well clear. ◆ When removing power plug, Do not pull from the cord, instead pul from the ends of the power cable. ◆ Please do not use the power supply that is beyond the specified electric voltage, as this may cause fire, injury or damage to the massage chair. ◆ Before using, please uncover the back cushion to check whether backrest or fabric is damaged; if damaged, please stop using this massage chair immediately, and contact manufacturer or distributor for repair immediately. ◆ Please do not operate the controller with damp hands, and do not put heavy objects on controller. ◆ This chair has a user weight LIMIT of 260 lbs. ◆ Please do not use other therapeutic equipment together when using this massage chair. ◆ During use, if you feel uncomfortable, immediately stop using the chair and consult your doctor. ◆ This massage chair is designed and NOT intended for COMMERCIAL USE. DO NOT use the massage chair for medical treatment. ◆ The massage chair is equipped with a heating function, for those who are sensitive to heat must use it carefully or refrain from activating the heating function. ◆ Always switch off power and unplug the power cord from the outlet immediately after use and before cleaning. ◆ To avoid causing discomfort, do not use the massage chair immediately after meals.
 PROHIBITED	<ul style="list-style-type: none"> ◆ In case the PU cover such as the back cushion or cloth cover is torn or damaged, please stop using the chair at once, and contact the distributor for instructions on how to repair. ◆ Do not sleep in the chair, when the massage chair is in operation. In the off position, sleeping is prohibited to prevent injury. ◆ Do not use the massage chair when intoxicated or under medication without the approval from your physician. ◆ When cleaning the chair do not use any toxic or alcohol based cleaner which may damage the chair covering. ◆ Do NOT improperly sit on the massage chair to avoid accidental injury or damage to the rolling mechanisms and motors. ◆ Please do not smoke while using the massage chair.
 REMOVE PLUG	<ul style="list-style-type: none"> ◆ Before maintenance, please pull out power cord. In addition, please do not insert or unplug the power plug with damp hands, to avoid electric shock. ◆ When the massage chair is not in use, turn off the switch on the back of the chair and proceed to unplug the power cord from the outlet.

NAME AND FUNCTION OF EACH COMPONENT

External structure

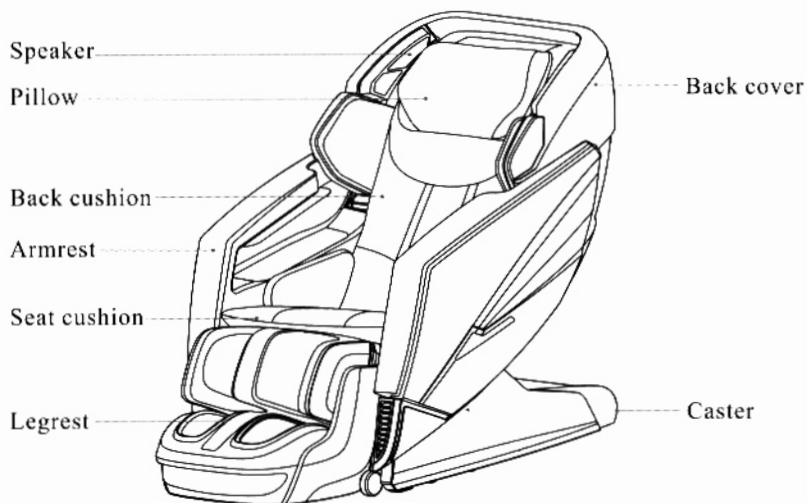

Internal structure

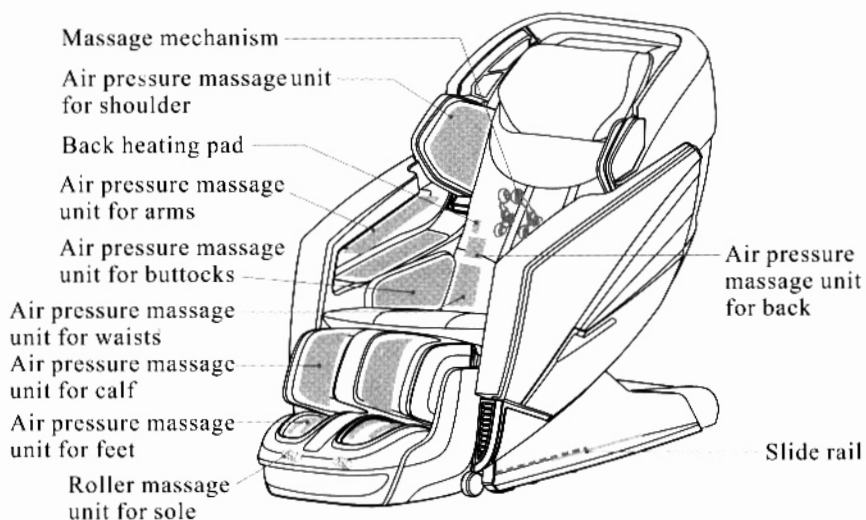

NAME AND FUNCTION OF EACH COMPONENT

Controller

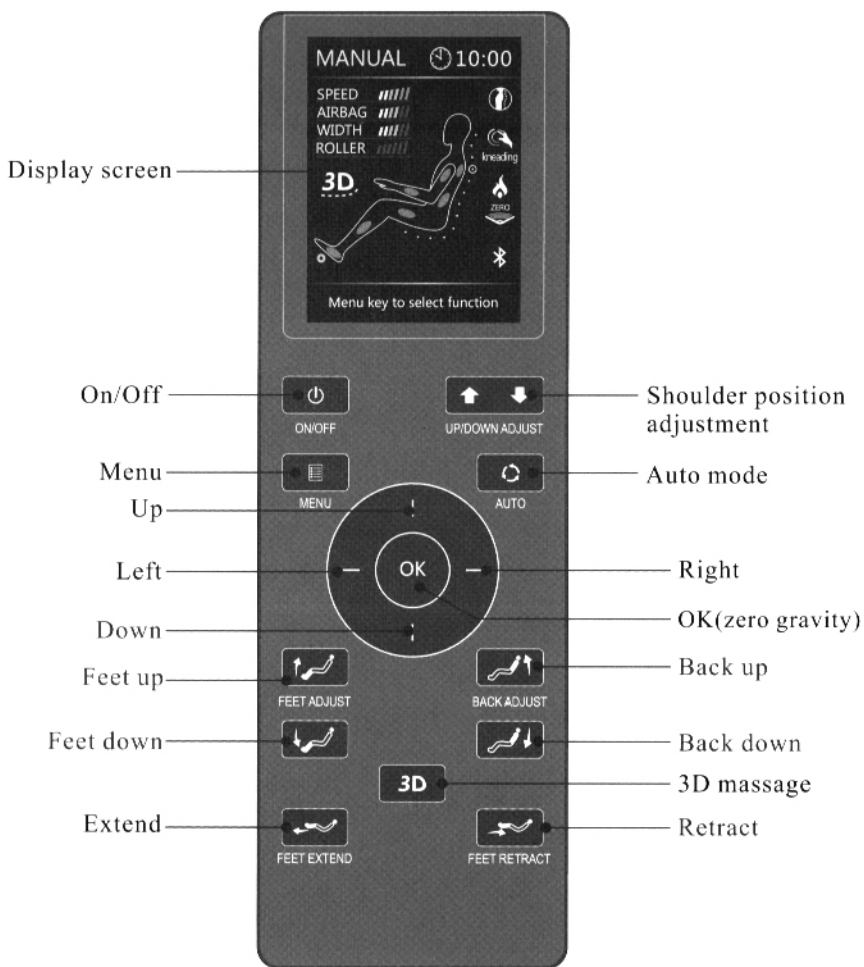

NAME AND FUNCTION OF EACH COMPONENT

Instruction of Controller



On/Off

- ▶ Press this button to power on and off the chair. After powering on the chair you can select a massage function either in the manual or preset program.



Menu

- ▶ This is the menu button allows you to select from many different massage functions. The display will provide different options which can be select by using the circular control pad.



Shoulder position adjustment (mechanism up and down adjustment)

- ▶ The up and down button allows you to control the position of the roller heads in the manual mode and in the preset program
- ▶ it will allow you to make minor adjustments on the starting point of the massage.



Auto programs

- ▶ This button will allow you to shuffle through the preset programs to select from (3D massage excluded). (See the LCD menu for detail)



Direction adjustment

- ▶ Under menu and auto mode, press the button to adjust direction. When program is determined, press the middle OK button to confirm it and enjoy the chosen massage.
- ▶ During the massage, press OK button to switch over zero gravity. Press up or down button to adjust mechanism speed. Press left or right button to adjust airbag force.



3D massage

- ▶ Under manual mode, press 3D button to adjust the 3D force.



Feet up

- ▶ Press and hold down this button to raise the legrest. Release the button and the legrest will stop moving.



Feet down

- ▶ Press and hold down this button to lower the legrest. Release the button and the legrest will stop moving.

▶ NAME AND FUNCTION OF EACH COMPONENT



Back up

▶ Press this button, the backrest will be moved up to the original position, release this button, it will stop.



Back down

▶ Press this button, the Backrest will be moved down to the lowest position, release this button, it will stop.



Legrest extend

▶ Press this button, the legrest will be extended to the longest position, releasing this button, it will stop.



Legrest retract

▶ Press this button, the legrest will be retracted to the original position, releasing this button, it will stop.



WARNING

▶ After massage has ended and has returned to the upright position, please press the power button to power off the chair.

Instruction of Display screen menu

▶ Auto mode

When turning on the power on the remote press the “auto” button the screen below will appear. Using the circular control on the remote you can chose from 6 different preset programs.

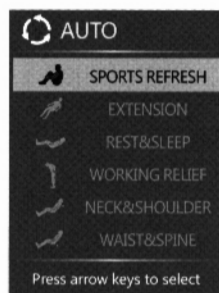
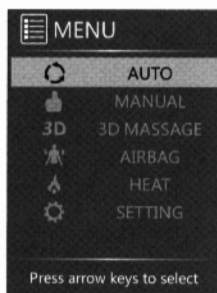

Sports refresh: This massage program is to massage the user after physical exercise to provide a deep massage to muscles using a combination of tapping and kneading.

Extention: This program uses a Thai style massage which is a strong kneading and stretching massage. The legrest will inflate, grabbing the legs and stretching out the body.

▶ NAME AND FUNCTION OF EACH COMPONENT

Rest and sleep: This preset program will vary the massage intensity using a variety of massage styles.

Working relief: This massage will focus on the lower back and the neck and shoulder a little more than the other areas.

Neck and Shoulder: This preset program will focus mostly in the neck and shoulder region.

Waist and Spine: This preset program will focus on the lower back region for the most of the massage program.

▶ Manual Programs:

Press Menu button, choose Manual and press it to enter manual programs. Press up or down button to choose mode, part, width, speed, roller or zero.

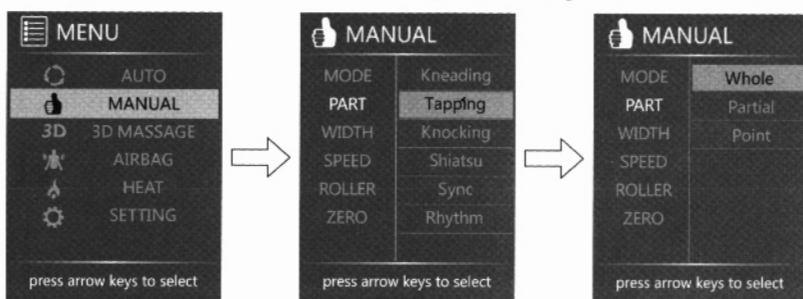

Mode: Under mode function, press right button first, then press up or down button to circulation choose massage manipulation of kneading, tapping, knocking, shiatsu, sync, or rhythm.

Part: Under Part function, press right button first, then press up or down button to circulation choose whole, partial or point. Back massage mechanism is by whole, partial and point.

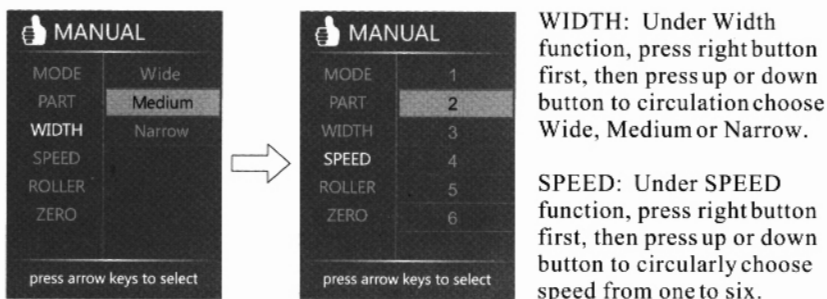

WIDTH: Under Width function, press right button first, then press up or down button to circulation choose Wide, Medium or Narrow.

SPEED: Under SPEED function, press right button first, then press up or down button to circularly choose speed from one to six.

▶ NAME AND FUNCTION OF EACH COMPONENT

ROLLERS: Press the MENU button first, then choose ROLLER, adjust the roller speed from 1 to 3 or stop the rollers by pressing up or down button. **ZERO GRAVITY:** The zero gravity setting, reclines the backrest, raising legrest and changes the angle of the seat base. The zero gravity function was created by NASA to provide maximum comfort while in the reclined position.

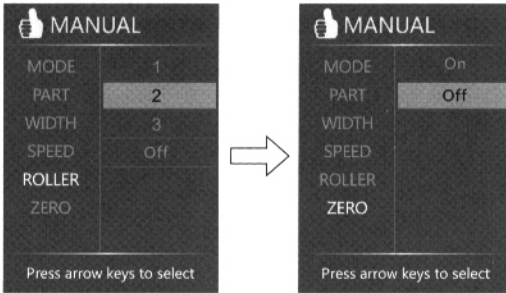

▶ 3D MASSAGE

Press MENU button first, then choose 3D, adjust the 3D MODE (Deep shiatsu, healthy breath, massage extend), massage force and part.

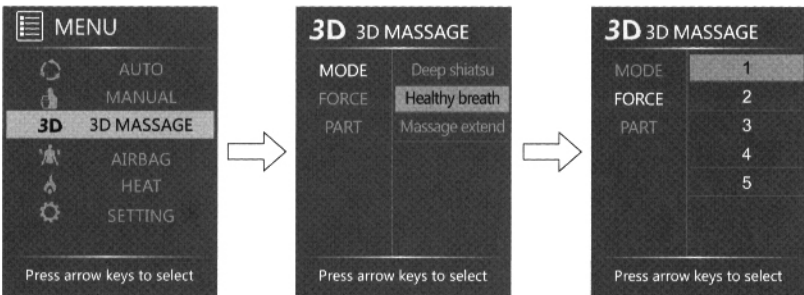

For the 3D massage programs you can select from “Deep Shiatsu, Healthy Breath and massage extended”

-Deep Shiatsu has a timer of 10 minutes.

-Healthy Breathe has a timer of 5 minutes

-Massage extend offers an additional 5 more in

FORCE: Under the force tab you can control the strength of the 3D massage up to 5 different intensities.

PART: Under Part function, press right button first, then select from whole, partial or point. This determines the area the massage chair will massage.

Depending on the starting point of the massage, in partial mode, it will do a half section.



▶ NAME AND FUNCTION OF EACH COMPONENT

▶ AIRBAG

Press MENU button first, then choose AIRBAG, press up or down button to choose airbag location and intensity.



PART:

Under AIRBAG function, press right button to select the areas you wish the airbags to function. Select from full, arm&shoulder, back&waist, leg & foot, or buttock.

FORCE:

Under AIRBAG when selecting FORCE, press right button select the airbag intensity ranging from 1 to 5 grades and stop the airbag.

▶ Heat

Click "MENU", choosing "HEAT", then click right to choose on or off.

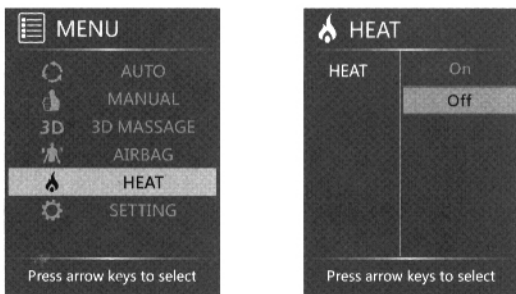

▶ NAME AND FUNCTION OF EACH COMPONENT

▶ SETTING

Press MENU button, choose SETTING, then press up or down button to set time, language or bluetooth.

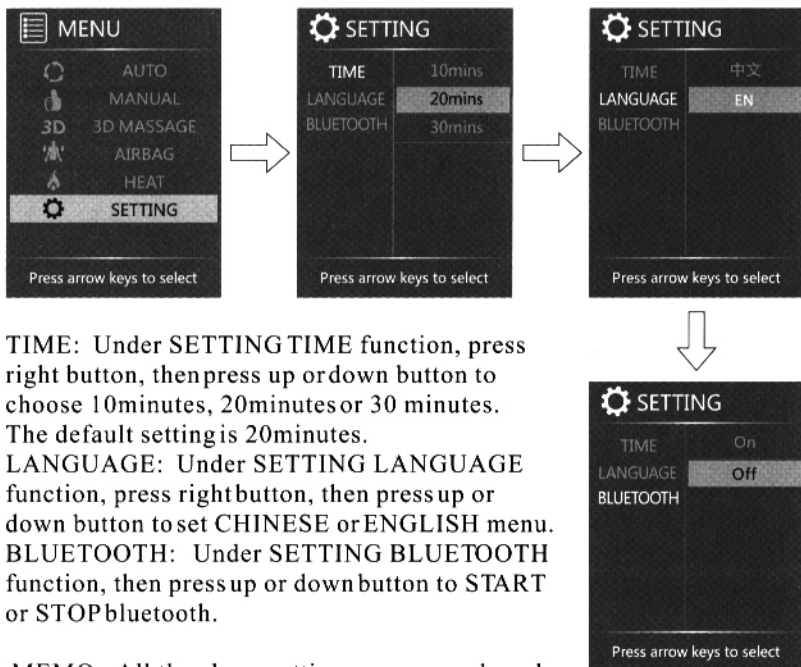

TIME: Under SETTING TIME function, press right button, then press up or down button to choose 10minutes, 20minutes or 30 minutes. The default setting is 20minutes.

LANGUAGE: Under SETTING LANGUAGE function, press right button, then press up or down button to set CHINESE or ENGLISH menu.

BLUETOOTH: Under SETTING BLUETOOTH function, then press up or down button to START or STOP bluetooth.

MEMO: All the above settings are remembered even when the machine is cut off suddenly.

▶ NAME AND FUNCTION OF EACH COMPONENT

Note:

1. Under auto mode or manual mode, it will go back to home page as below drawing 10 seconds after without any operating.

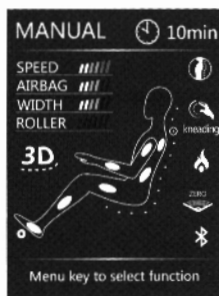

Home page in manual mode

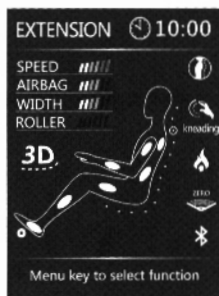

Home page in auto mode

! Caution

- ▶ When the remote is on, clicking the "menu button" twice and it will go to the home page immediately.
- ▶ In the home page, under manual mode or auto mode, click the left and right button to adjust air pressure intensity; under manual mode, click up and down, to adjust massage head speed which will effect the intensity.
- ▶ Click "AUTO" to choose auto program directly.

! Caution

- ▶ Do not disassemble the chair for any reason or tamper with the chair to modify or fix.
- ▶ Be sure the remote and the chair makes no contact with any liquids to avoid electrical injury and damage to the chair
- ▶ Be sure the power cord does not have anything laying on top of it. This may cause damage to the wire and also result in an electrical short.

► PREPARATION BEFORE USING

Installation Method

Step 1: Get out each part of the chair

- Unpack the cartons, carefully gather the bolts and parts, accessories box and massage chair components.
- Make sure all parts are accounted for according to the assembly diagram.

Step 2: Armrest assembling

- Lift the right armrest and insert the armrest connector into the base of the chair. Find the labeled numbers on the black air hose coming from chair main body, then connect the air hose with right armrest with the with the matching number.
- Connect the armrest with chair backrest stand and make sure it is securely inserted. Use the screw and washer to fix the right armrest with chair main body (left armrest same)

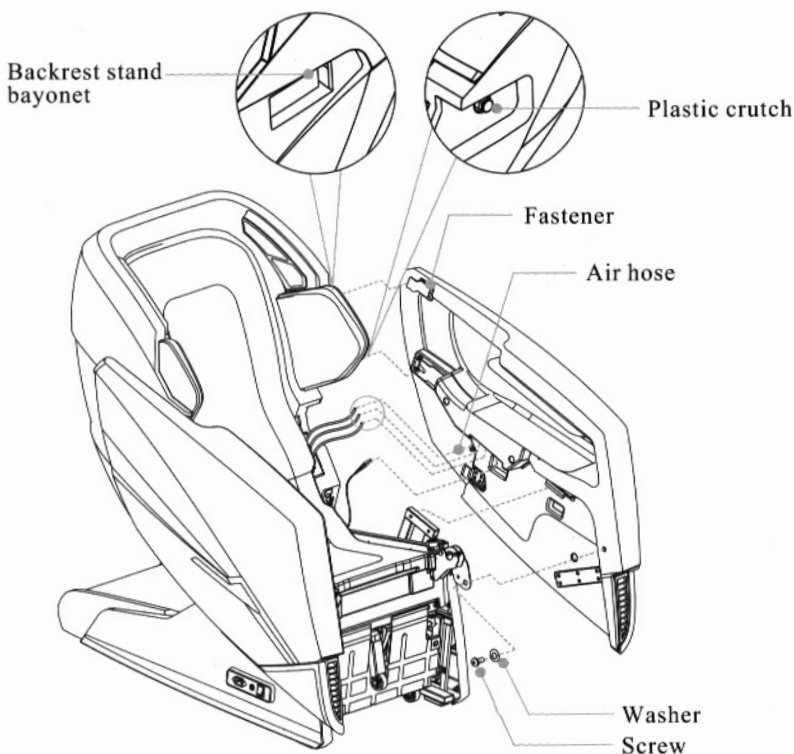

▶ PREPARATION BEFORE USING

Step 3 Installation of legrest unit

- ▶ Install the inner cover and outer cover of leg frame onto the connecting shaft.

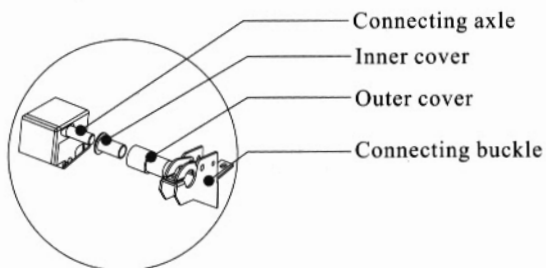

- ▶ Open hook and place the chair legrest connecting axle in the hook, then fix hook by screws.

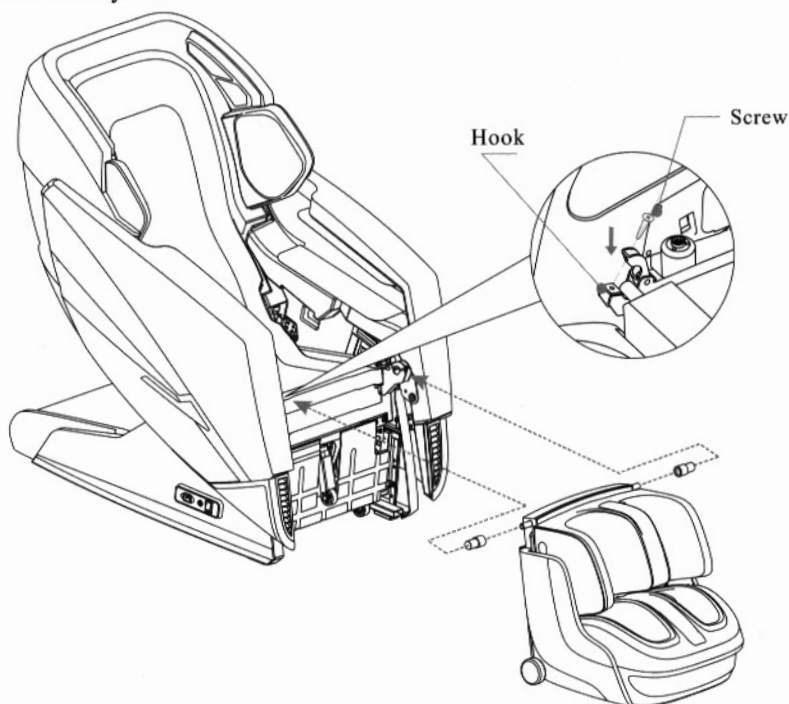

► PREPARATION BEFORE USING

- Lift legrest section and located at the top right corner you find both the air line connection and the leg drive connection. (Fig below)

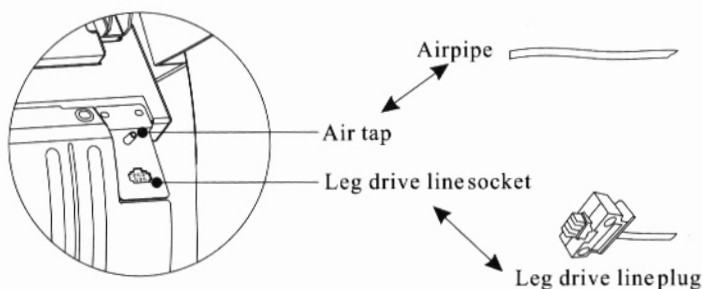

Step 4 Installation of controller unit

- Connect the data line of the controller to the port on the inner side of right armrest(pay attention to the convex-concave between connector and port); then fix the screw cap. (see the figure below)

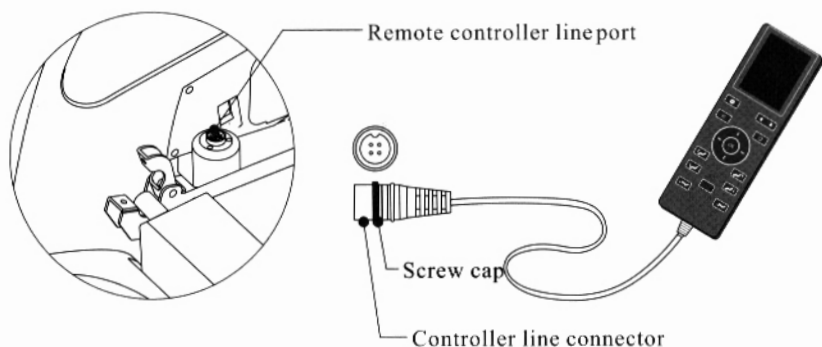

▶ PREPARATION BEFORE USING

Step 5 Other Accessories

- ▶ Connect the power cord connector to the port on the outer side of right armrest;
- ▶ Switch on the chair, and use the controller to raise the backframe to normal position.

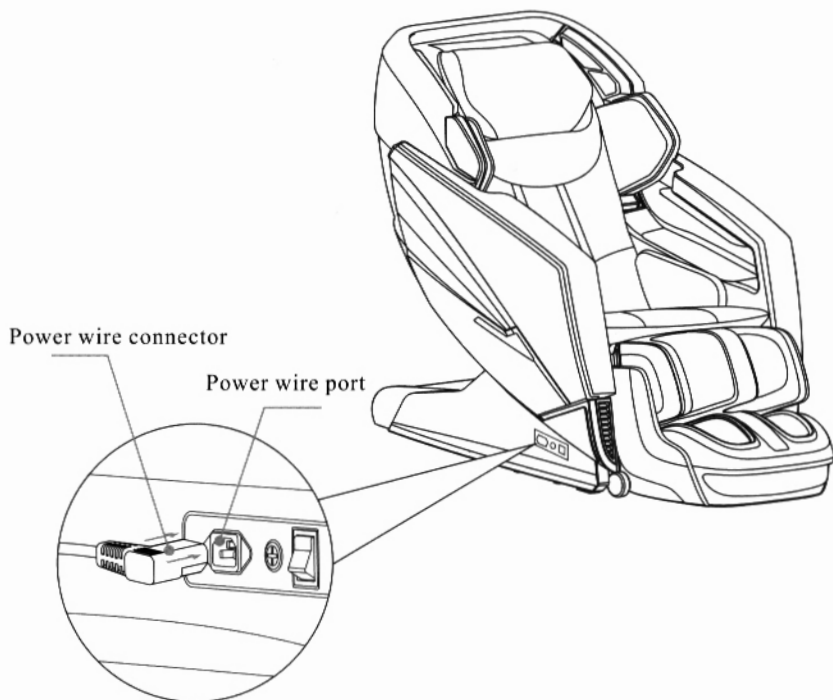

▶ PREPARATION BEFORE USING

Move method

- ▶ There are moving rollers at the bottom of the chair.
- ▶ Be sure the chair is at the full upright position before attempting to move. Be sure to turn off from the switch in the back and remove from the power outlet. Lift the front part of the chair as shown in the figure (one person raise the front part firmly grabbing the backrest handles, another person push the chair when holding the top of the chair), move the chair by the rollers.

DO NOT ROLL THE CHAIR ON SOFT ENGINEERED WOOD OR ANY OTHER SOFT SURFACES

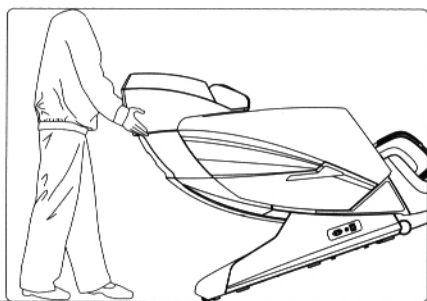

Caution

- ▶ Don't move the chair when there are people in it.
- ▶ Don't grab on the armrest or other parts to move the chair other than the footrest and backrest when moving. See picture above.

Turn on power supply

- ▶ Located on the side bottom of the chair is the power switch.
- ▶ When plugging into a 3 pronged certified outlet be sure the switch is off.

Caution

- ▶ Before switching on the chair, please make sure there is no damage on the power cord and other exposed wires.
- ▶ Make sure the power switch is off before the chair is connected to electricity. Be sure all prongs are in good condition.

► PREPARATION BEFORE USING

Installation position

Safety distance for the periphery of massage chair.

- Please make sure there is adequate space for installation this product:
Back: minimum 10cm from the wall or any other blocks;
Front: minimum 60cm from any blocks;
- In order to prevent from signal interference, please keep at least 1m away from the TV, radio and other video and audio devices.

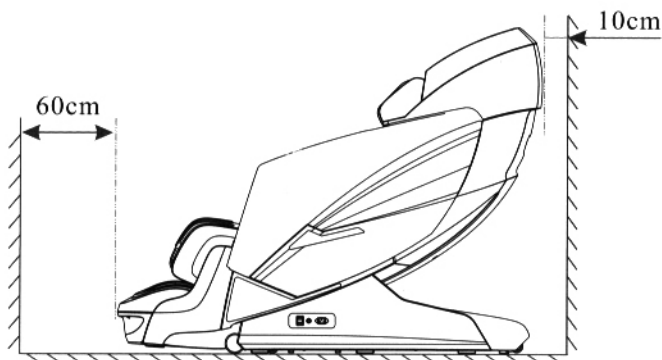

- When installation, the distance between the power socket and the power switch must be within 1.5m.

⚠ Caution

- Make sure the distance from the chair to the power outlet is less than 6 feet.
- Please make sure there are no obstructions or items surrounding the chair to avoid injury and damage to the chair.
- No children should be near the chair when operating the chair especially when reclining.

PREPARATION BEFORE USING

Floor protection

- ▶ Please put carpet or other pad under the massage chair, in order to avoid any unpredictable impression on the floor and to reduce the noise.

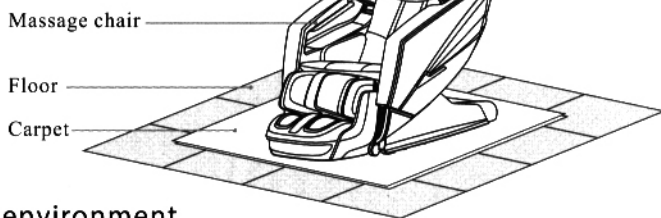

Surrounding environment



Keep the massage chair away from damp places (for example: bathroom) to avoid electric shock and serious injury. Moisture will cause serious electric failure and damage.



Keep the massage chair away from high temperature sources (for example: stove, heaters, windows) to avoid fire, discoloration or damage to upholstery material.

GROUNDING INSTRUCTIONS

This product must be grounded in the event of an electrical malfunction. Grounding provides a low resistance path for the electric current to reduce the risk of electric shock. The cord is equipped with a built-in equipment-grounding conductor and a 3-prong grounding plug. This plug must be used with an appropriate outlet installed and grounded in accordance with all local codes and ordinances.

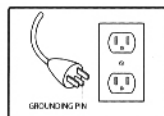

⚠ DANGER

- ▶ Improper connection of the equipment-grounding conductor can result in a risk of electric shock. Check with a qualified electrician or serviceman if you are in doubt as to whether the product is properly grounded. Do not modify the plug provided with the product – if it will not fit the outlet, have a proper outlet installed by a qualified electrician.
- ▶ This product is for use on a nominal 120-volt circuit and has a grounding plug that looks like the plug illustrated. Make sure that the product is connected to an outlet having the same configuration as the plug. No adapter should be used with this product.

GROUNDING

This massage chair belongs to Class I of the IEC Protection Class. Be sure to use a three-core power supply socket. To avoid electric shock, leakage, or other electric risk, ensure the ground wire connected to the power supply has obtained a stable ground connection.

▶ PREPARATION BEFORE USING

Check before using the Massage chair for the 1st time

- ▶ Before using the chair, please make sure there is enough space around the chair. Make all things are cleared around the chair. Then use the controller to recline the chair backrest to the maximum position, rise up the legrest to the highest position and stretch out to the maximum length.
- ▶ Once the chair has been fully tested and all functions are confirmed to be working, the chair is now ready to be used. Carefully review manual to familiarize yourself with the functions.

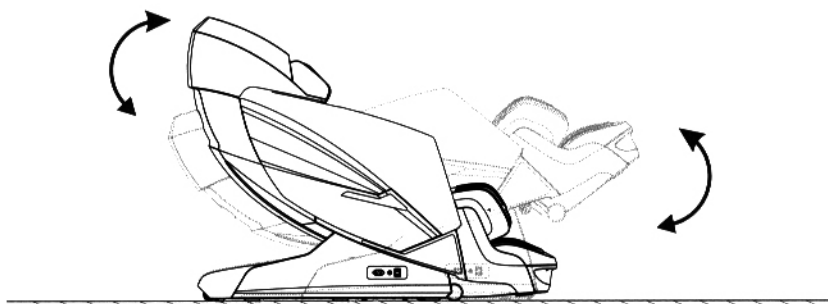

Before sitting in the chair

- ▶ Make sure the legrest is well installed and the bolts are firmly secured.
- ▶ Make sure the chair is in the full upright position before sitting in the chair. The legrest must be completely down before stepping in chair to avoid the motor from burning out.

Caution

- ▶ If the legrest rises up, please do not seat on the chair.
- ▶ anism. The legrest is not intended to bare any excessive weight load aside from the weight of the legs in the rest position. Do not apply any additional force on the legrest.

▶ PREPARATION BEFORE USING

Legrest Extend and Retract

- ▶ Using the remote control the legrest can be extended out or retracted to adjust to the users leg length. This will ensure that the rollers at the base of the footrest will massage the bottoms of the feet.

Legrest extending out — 

Legrest retracting — 

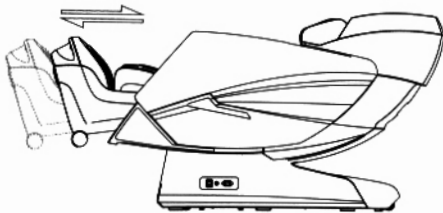

- ▶ Legrest can be extended or retracted automatically or manually according to different position and height, because of sensor inside

WARNING

- ▶ Do not play in the chair and conduct improper operations. Before adjusting the backrest and legrest, be sure that there are no loose articles of clothing, sharp objects or any body parts that can get caught or squeezed in the cracks of the chair. This may lead to serious injury.
- ▶ Do not get out of the chair until the chair is fully upright in the default position. If you attempt to get out of the chair prior the chair getting to the default position, it may lead to serious injury or lead to damaging the chair.

After using

- ▶ Please power off the chair and unplug the power cord from the outlet after using the chair. This is recommended in case there is a power shortage due to storms and power outages which may cause an electrical short.
- ▶ Be sure the remote is properly stored way into the slot designed to keep the remote. If the chair is not going to be used for a long duration of time you may consider covering the chair to prevent dust from entering into the electrical components.

Bluetooth connection method

Apple iOS app is different from android, please see the details below:

Apple ios:(ipad for example)

1. On your Apple device go to the App Store, and download the app with the keywords "rongtai, rongtai massage chair, 8720S(8600/8600S). Once downloaded go to your Bluetooth settings and connect it with the massage chair. Your apple device requires that it is equipped with bluetooth 4.0 in order to get connection with the chair.
2. Open the APP and make sure the chair is connected through Bluetooth and begin to use the APP control .

Blue tooth

- ▶ Once the chair is connected through Bluetooth you will be able to hear the music or audio playing on your device through the speakers built into the chair.
- ▶ There is extra audio inputting cable for other audio devices next to the controller socket. (optional)

Android System

Software

- ▶ Download the APP to your android device. The APP will be under "Rontai" or "8720S" or "OS-Pro Ekon".
- ▶ Once installed on your device proceed to connecting the chair through Bluetooth. Go to your wireless Bluetooth settings and search for "OS:PRO-EKON", then pair. Once the chair has been paired go to the APP and it is ready to use.



Caution

- ▶ In order for the chair to discover the Bluetooth signal, the chair MUST be turned on.
- ▶ If your first attempt fails turn off the chair and restart by turning off the power from the switch on the base of the chair.
- ▶ Please be sure your android device is up to date with software upgrades.

Equipment requirements

- ▶ Your PC or mobile device must have the Bluetooth feature in order to utilize the online APP.
- ▶ The minimum software requirement is the V2.2 Android System.

▶ PRODUCT STORAGE AND MAINTENANCE

Maintenance

- ▶ Use a damp cotton cloth and ring out any excessive liquids, neutral detergent before wiping the back cover, hand rest, legrest, air tube and some other plastic components, then use a dry cotton cloth to wipe them again.

It is important that a non-toxic or no-alcoholic cleaner is used to prevent the upholstery from drying out and being damaged.

Caution

- ▶ Make sure to pull out the power supply plug firstly before doing any cleaning maintenance. Do not use wet hands to pull out the plug to avoid electrical shock. When cleaning the back cover, please be cautious of detergent or fluids from entering into the power supply box!
- ▶ Keep the chair away from any hot items.

Storage method

- ▶ Wipe off dust and dirt from the product after use, if the product is not to be used for a long period of time, please cover the product with a dust cover (self provided).

Caution

- ▶ Do not store the product under direct sunlight or in places with warm to high temperatures. This may cause the color of the upholstery to fade.

Kind reminding

During daily use, please check whether the following symptoms exist. Be sure there is no scorched or burning smell coming from the chair. Make sure the cloth material on the backrest has no damage or tearing. Finally make sure the power the cord has no visible damage.

Caution

- ▶ If any abnormal symptoms appear, stop using the chair and unplug from the outlet immediately. Contact the distributor for further instructions.
- ▶ ONLY authorized technicians are qualified to work on the massage chair.
- ▶ If not, the warranty will be void and may lead to serious injury.

▶ TROUBLE SHOOTING

No.	Problem	Possible Cause	Solution
1	If you hear a hissing or mild rubbing sound from the chair	The sound is created when the massage ball rubs against the backrest cover and from the air pumps.	It is a normal condition. These sounds are generated when being used.
2	The chair will NOT turn on.	The power cord is not completely plugged into the wall	Check outlet and firmly plug into the wall
		The power switch at the base of the chair is NOT on.	Turn the switch to the on position.
		The fuse at the back base of the chair is blown out.	Replace the fuse with the same rating
3	No sound from the speaker	The volume is set to the lowest setting	Turn the volume up using the remote and device
4	The backrest or the legrest are moving up and down	The max. weight capacity has been exceeded or the motor has failed	No one more than 260lbs should use this chair. Call the manufacturer if the motor is burnt out.
5	Certain air bags are not inflating	The air hose maybe folded or crimped leading into the airbag.	Follow the hose that is blocked to make sure all connections are good and unfolded

If the problem is unresolved after taking the above, please contact local distributor for repair and maintenance.

Note: Do not dismantle the product by yourself, and our company shall shoulder no responsibility to the damage of the product or the injury of people caused by unauthorized tampering!

TECHNICAL SPECIFICATIONS

Name: Deluxe Multi-functional Massage Chair

Model: PRO-EKON

Rated voltage: 110-120V~

Rated frequency: 60 Hz

Rated current: 1.5A

CAUTION

IMPORTANT SAFETY INSTRUCTIONS

Read all instructions before using this massage chair.

DANGER - To reduce the risk of electric shock, injury or damage please follow the instructions below.:

1) Always unplug the massage chair from the electrical outlet immediately after using and before cleaning.

WARNING- To reduce the risk of burns, fire, electric shock, or injury to the user:

1) Never operate the chair unattended. If not in use please unplug the power cord from the outlet.

2) Do not use this chair with any blankets or loose material. Excessive heating can occur and cause fire, electric shock, or injury to persons.

3) Close supervision is necessary if there are children or pets near the massage chair. It is advised that there is at least a 10 feet distance from children and pets.

4) Use this massage chair only for its intended use as described in this manual. Do not use attachments not recommended by the manufacturer.

5) Never operate this massage chair if it has a damaged cord or plug, if it is not working properly, if it has been dropped or damaged, or has significant contact with liquids, Contact your service center for examination and repair.

6) Do not grab the chair by the power cord or any other cable when moving the massage chair.

7) Keep the cord away from heated surfaces.

8) Never operate the massage chair with the air vents blocked. Keep the air openings/vents free of lint, hair, and other obstructions.

9) Never drop or insert any object into any opening.

10) Do not use outdoors.

11) Do not operate where aerosol (spray) products are being used or where oxygen is being administered.

12) To disconnect, turn all controls to the off position, then unplug from the outlet.